

ΠΑΡΑΡΤΗΜΑΤΟΣ ΤΗΣ ΕΠΙΣΚΟΠΗΣ  
HERMOPOLIS & ANTENOEPOLIS  
COPTIC ORTHODOX DIOCESE OF MALLAWI  
مطرائية ملوي وأنصنا والأشمونين للأقباط الأرثوذكس

Πίχωμ ἵςθαί  
ἔπιχινῆσαι ἕμετρεμῆχημ

كراسة الخط القبطي

إعداد

الأنبا ديمتريوس

أسقف ملوي وأنصنا والأشمونين



Πίχων ἱςδαί : اسم الكتاب  
ἡπιχίνςδαί ἡμετρεῖῆχνη  
كراسة الخط القبطي

إعداد : الأنبا ديمتريوس

أسقف ملّوي وأنصنا والأشمونين

المطبعة : مطبعة دير مارمينا العجائبي بمريوط

موبايل: ٠١٢.٥٥٥.٤٤١ & تليفاكس: ٠٣٤٥٩٦٤٥٢.

الناشر : مطرانية ملّوي.

الجمع التصويري : مطبعة مطرانية ملّوي.

الطبعة : الثانية - أغسطس ٢٠١٤ م

رقم الإيداع : ١٦٦٧٦ / ٢٠١٣

أ. العنوان : ٠٧ , ٤٩٣



**Παπα Δββα Ταωδροσ**

Πιμαρ Β̄ ( πιμαρ ρ̄ιη )

**Н.Н Pope Tawadros II, 118<sup>th</sup>**

Pope and Patriarch of Alexandria and the See of St. Mark

**البابا الأنبا تواضروس الثاني**

بابا الإسكندرية وبطريك الكرازة المرقسية ال ١١٨



**ΑΒΒΑ ΔΗΜΗΤΡΙΟΣ**

**ΠΙΕΡΙΣΚΟΠΟΣ ἸΤΕ ΜΑΛΛΑΥ ΝΕΜ ΔΗΤΗΝΩΟΥ ΝΕΜ ΨΜΟΤΗ**

**H.G. Demetrius**

**Bishop of Mallawi, Hermopolis & Antenoepolis**

**الأنبا ديمتريوس**

**أسقف ملوى وأنصنا والأشمونين**



## القدمة

بنعمة الله أُقدِّم هذا الكتاب:

# Πιχωμ ἰςδαι ἕπιχινῆδαι ἕμετρεμῆχημ

## كراسة الخط القبطي

لُمُحِبِّي اللغة القبطية كتمرين للكتابة أو كراسة خط.

وقد روعيَ فيها تكرار الحرف بمقاسات مختلفة، فبيدأ الدارس بكتابة الحرف بالمقاس الكبير، فيكون احتمال الخطأ (نسبة الخطأ) أقل ثم ينتقل إلى المقاس الأصغر فالأصغر، وهكذا يكون التكرار مفيد وغير مُملّ، وترتيب الخطوات المعروضة هنا استرشادية وليست إجبارية فقد يستحسن الدارس البداية بأية خطوة، وليس بالضرورة الخطوة رقم (١) ولكن هذا الترتيب يستحسنه كثيرون.

في الجزء الثاني من هذه الكراسة بعض الكلمات والأسماء والآيات القصيرة كتطبيقات وتمارين للكتابة، فيتدرّج الدارس من الحرف إلى الكلمة ثم إلى الجملة (الآية).

الربُّ يُبارِك هذا العمل بشفاعات أمنا العذراء القديسة مريم، وطلبات القديس مارمرقس الإنجيلي، وصلوات قداسة البابا المُعظَّم الأنبا تواضروس الثاني. آمين.

بنعمة الله

**ديمتريوس**

أسقف ملّوي وأنصنا والأشمونين



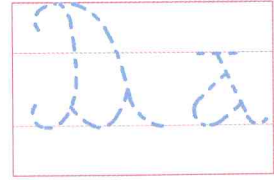
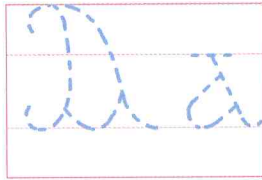
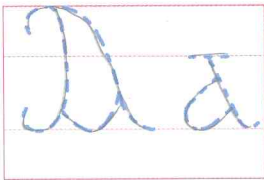
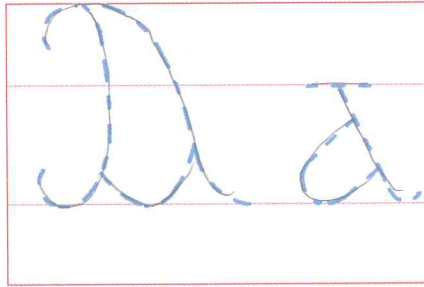
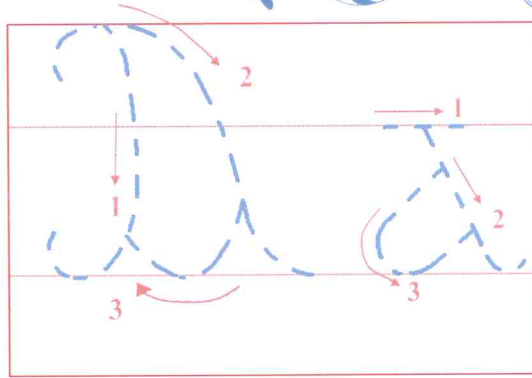
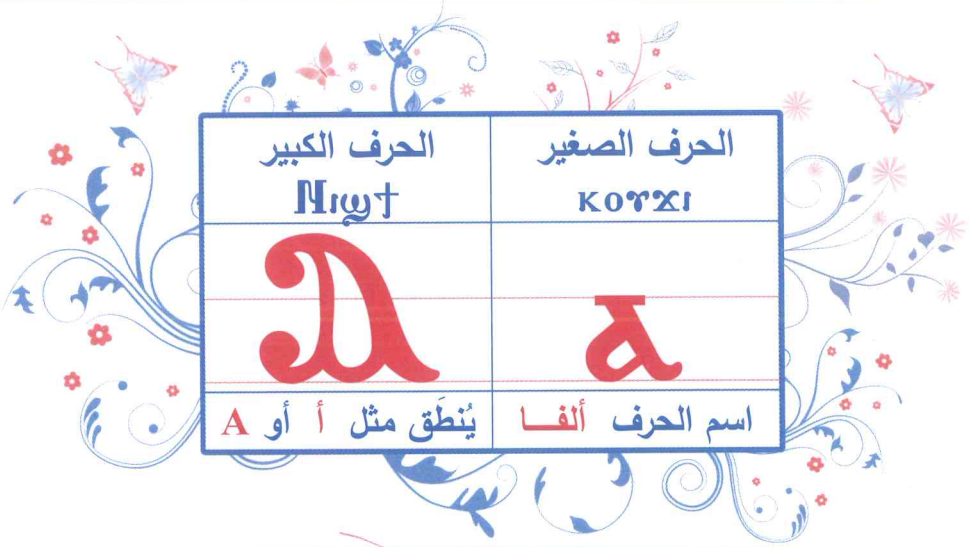

+ كرّر العمل في باقي المقاسات.

+ وصل النقط مُتتبعاً الأسهم في الشكل الكبير.

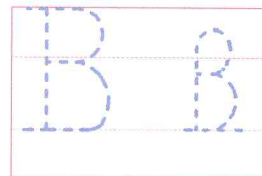
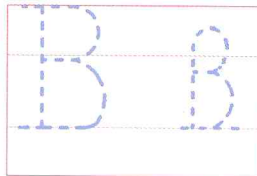
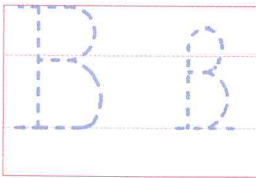
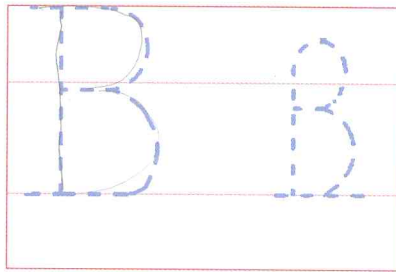
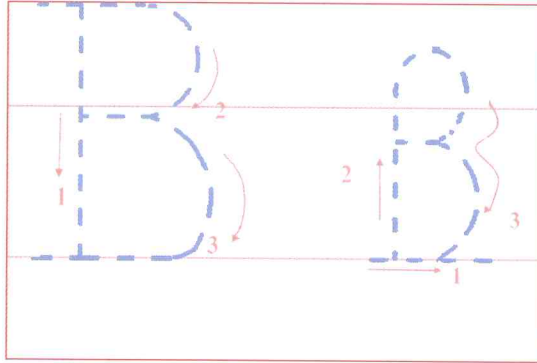

+ كَرِّرِ العَمَلِ فِي بَاقِي المَقَاسَاتِ.

+ وَصِّلِ النِّقَطَ مُتَّبِعاً الأَسْهُمَ فِي الشَّكْلِ الكَبِيرِ.

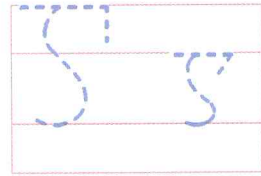
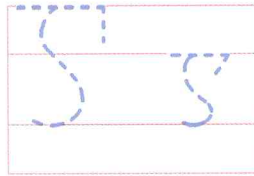
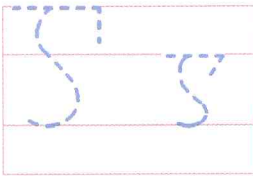
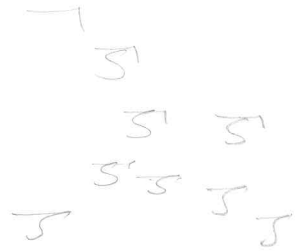
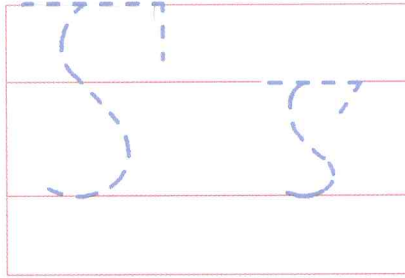
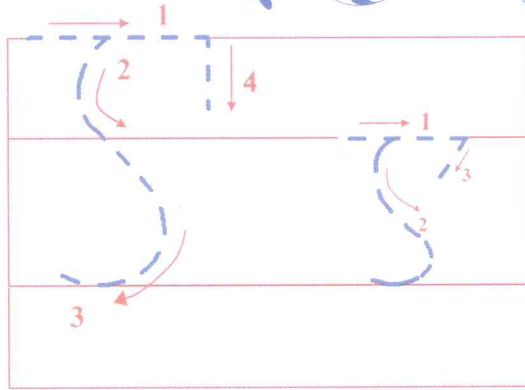

+ كَرِّرِ العَمَلِ فِي بَاقِي المَقَاسَاتِ.

+ وَصِّلِ النِّقَطَ مُتَتَبِعاً الأَسْهُمَ فِي الشَّكْلِ الكَبِيرِ.

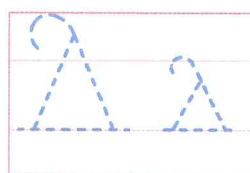
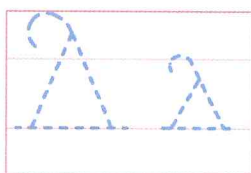
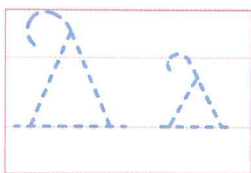
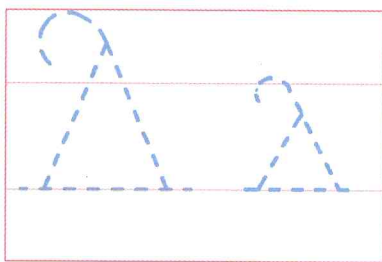
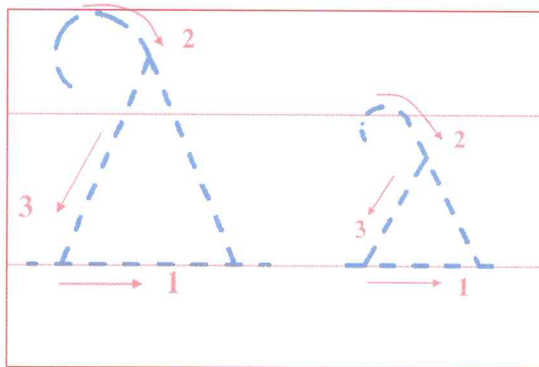

+ كَرِّرِ العَمَلِ فِي باقِي المَقاسَاتِ.

+ وَصَلِ النُقْطَ مُتَبَعاً الأَسْهُمَ فِي الشَّكْلِ الكَبِيرِ.

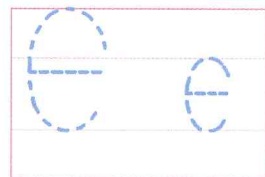
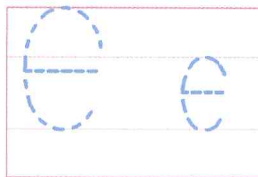
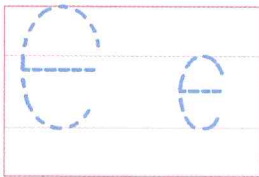
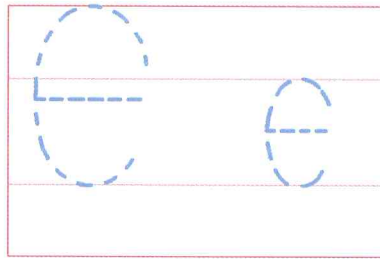
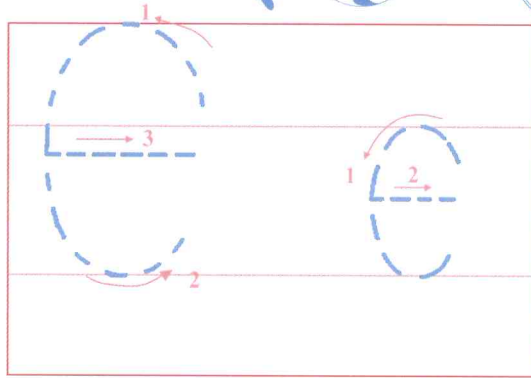
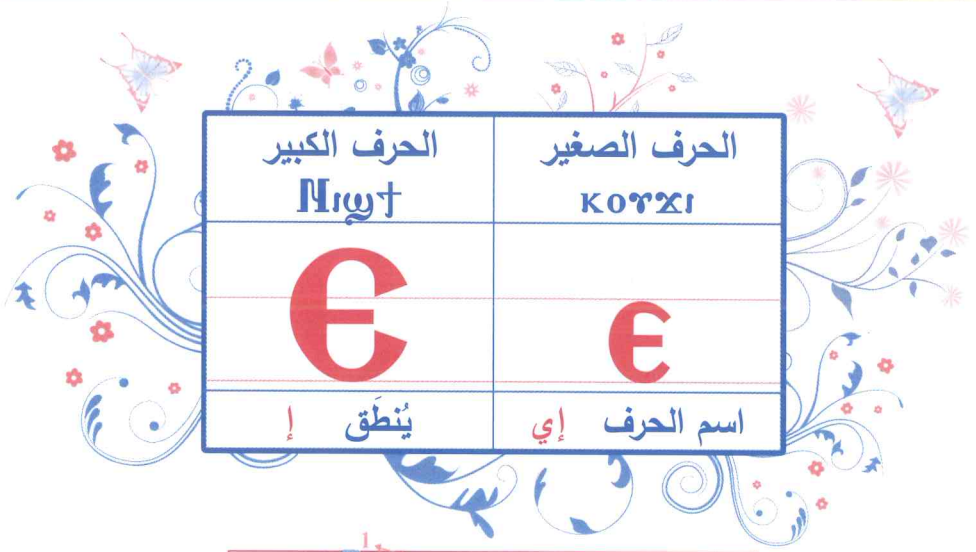

+ كَرِّرِ العَمَلِ فِي بَاقِي المَقَاسَاتِ.

+ وَصِّلِ النُّقْطَ مُتَّبِعاً الأَسْهُمَ فِي الشَّكْلِ الكَبِيرِ.

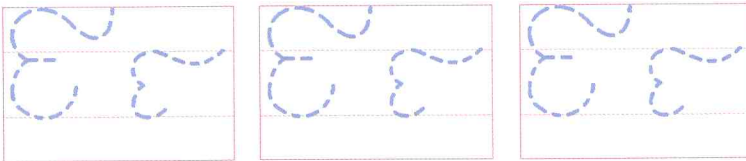
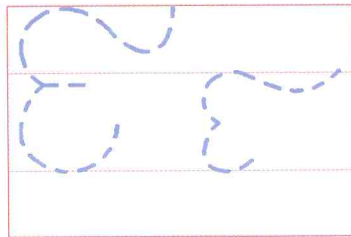
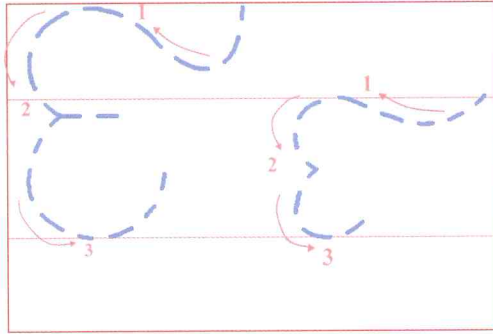

+ رقم ٦ = ع ، ويُنطق سو (cooy)

+ كرّر العمل في باقي المقاسات.

+ وصل النقط مُتتبعاً الأسم في الشكل الكبير.

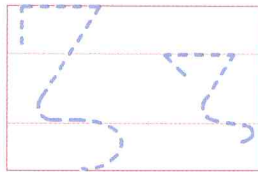
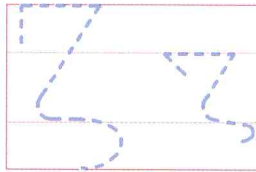
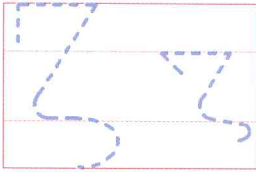
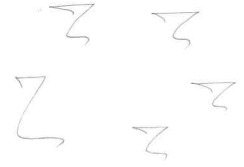
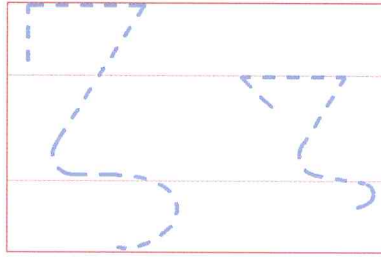
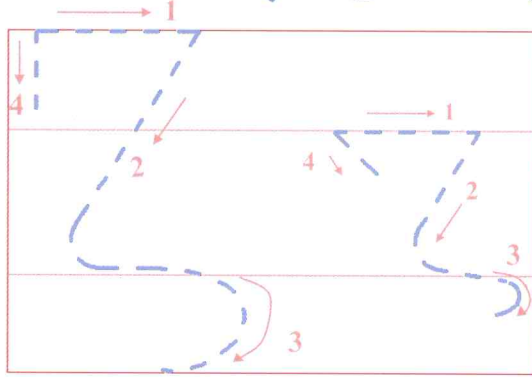

+ كَرِّرِ العَمَلِ فِي بَاقِي المَقَاسَاتِ.

+ وَصِّلِ النُّقْطَ مُتَتَبِعاً الأَسْهُمَ فِي الشَّكْلِ الكَبِيرِ.

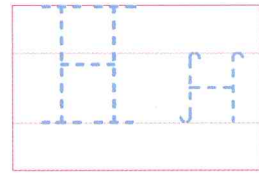
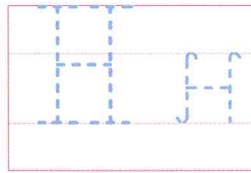
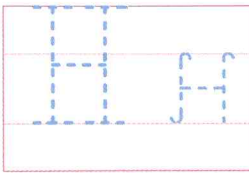
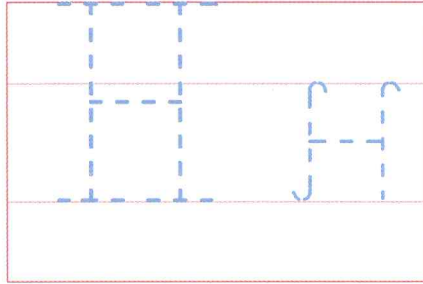
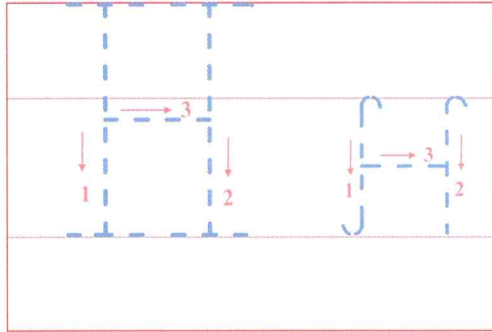
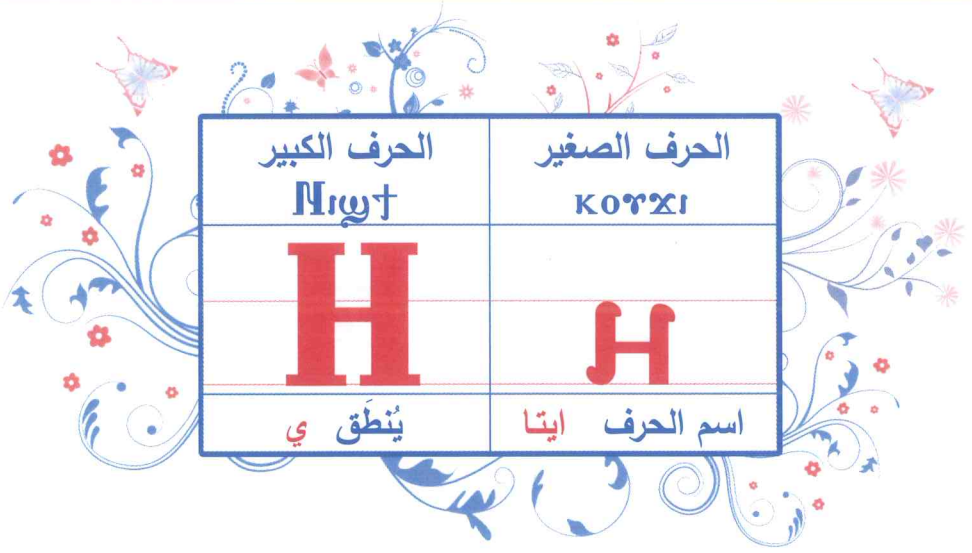

+ كَرَّرَ العمل في باقي المقاسات.

+ وَصَلَ النقط مُتتَبِعاً الأَسْهُمَ في الشكل الكبير.

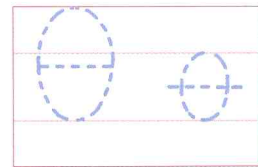
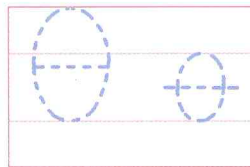
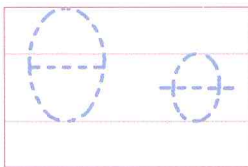
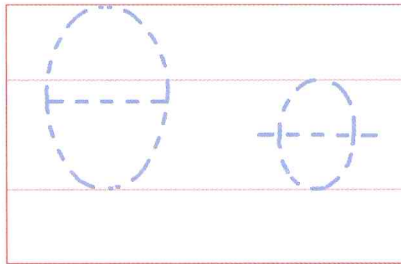
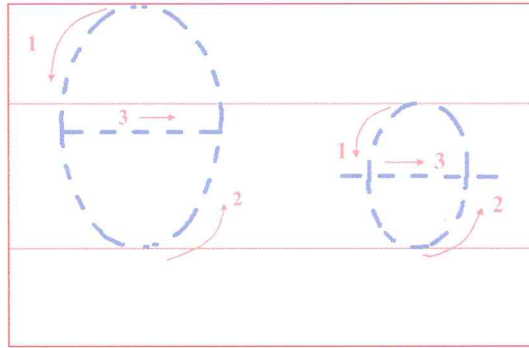

+ كَرَّرَ العمل في باقي المقاسات.

+ وَصَلَ النقط مُتَّبِعاً الأَسم في الشكل الكبير.

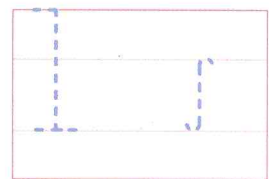
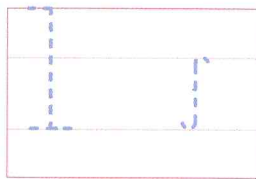
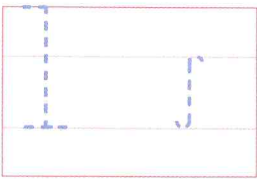
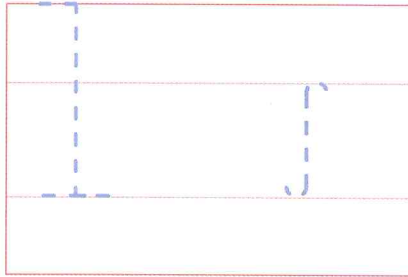
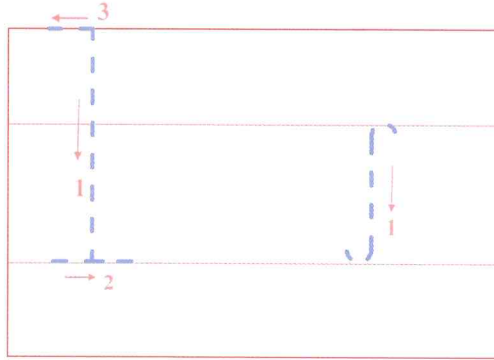

+ كَرَّرَ العمل في باقي المقاسات.

+ وَصَلَ النقط مُتَّبِعاً الأَسْهُمَ في الشكْلِ الكَبِيرِ.

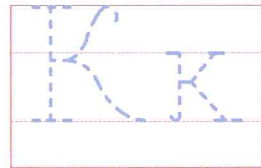
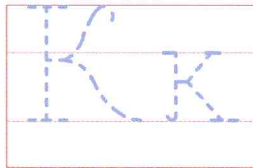
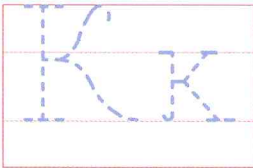
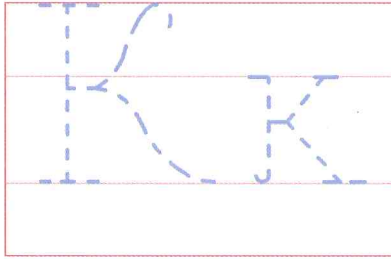
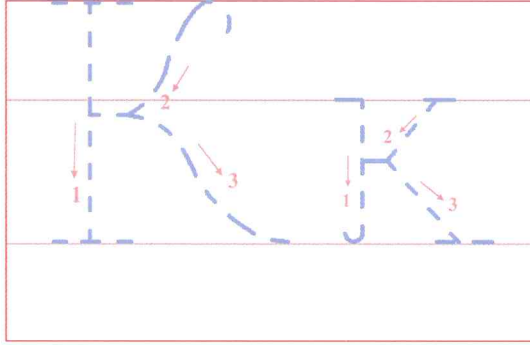
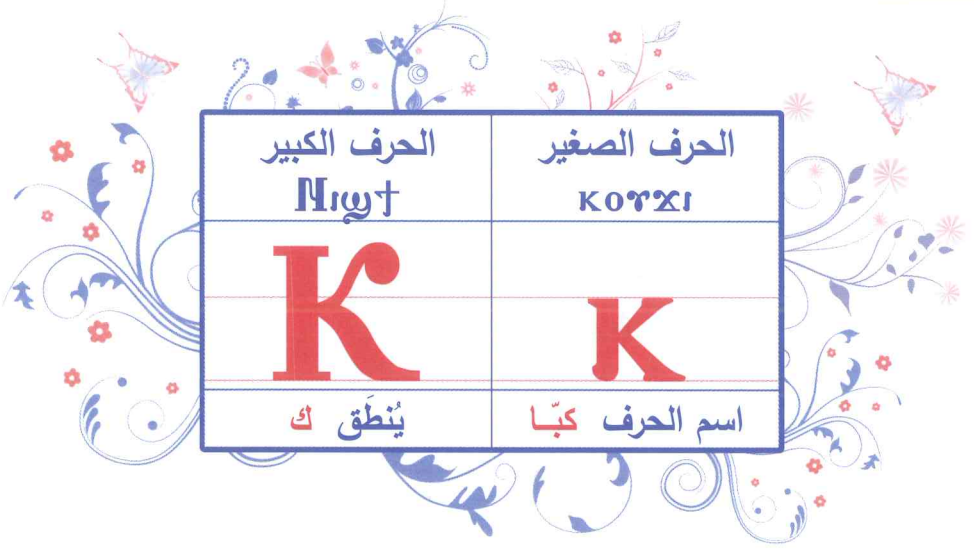

+ كَرِّرِ الْعَمَلِ فِي بَاقِي الْمَقَاسَاتِ.

+ وَصِّلِ النِّقْطَ مُتَّبِعاً الْأَسْهُمَ فِي الشَّكْلِ الْكَبِيرِ.

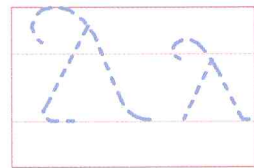
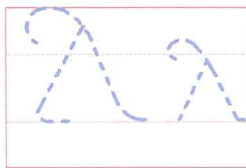
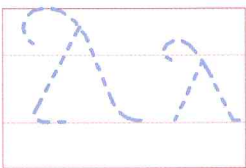
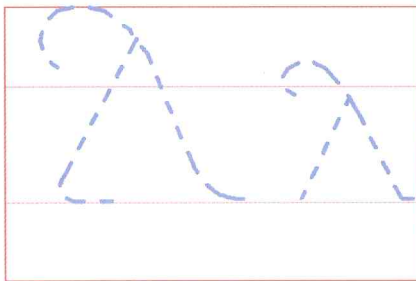
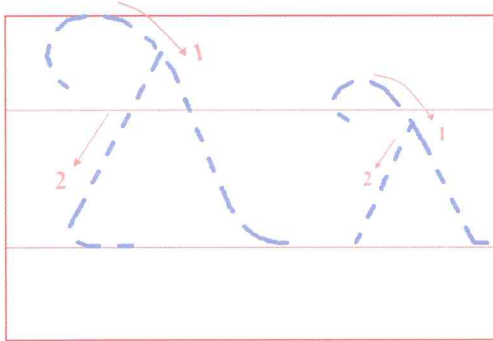

+ كَرّر العمل في باقي المقاسات.

+ وَصّل النقط مُتتبعاً الأسم في الشكل الكبير.

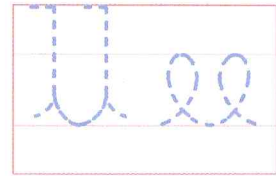
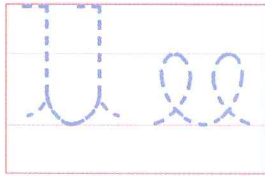
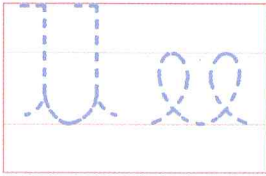
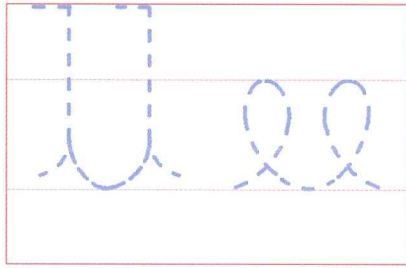
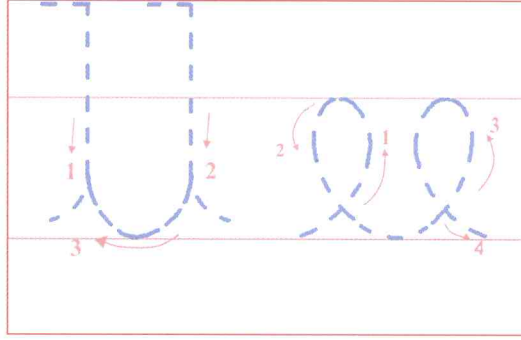
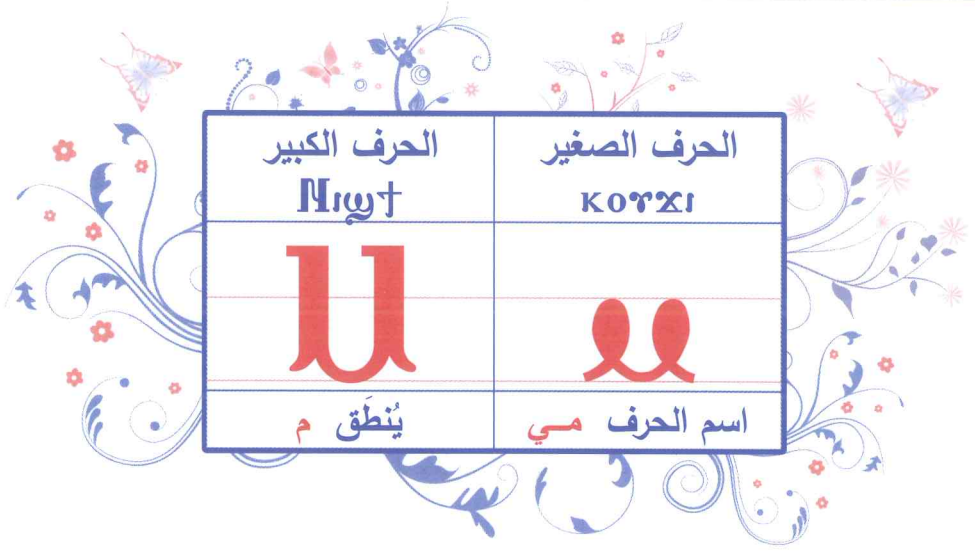

+ كَرِّرِ الْعَمَلِ فِي بَاقِي الْمَقَاسَاتِ.

+ وَصَلِ النِّقْطَ مُتَّبِعاً الْأَسْهُمَ فِي الشَّكْلِ الْكَبِيرِ.

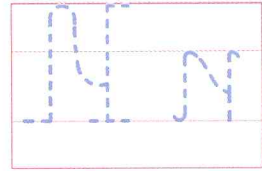
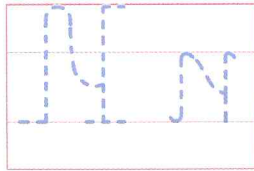
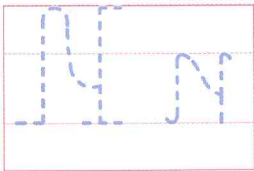
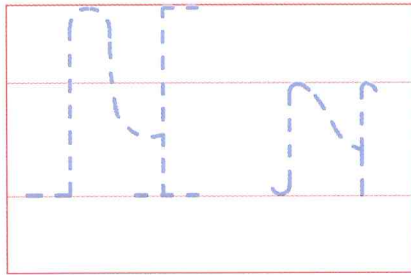
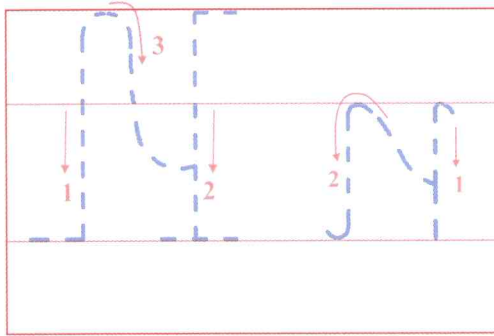

+ كرّر العمل في باقي المقاسات.

+ وصل النقط مُتتبعاً الأسهم في الشكل الكبير.

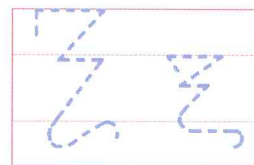
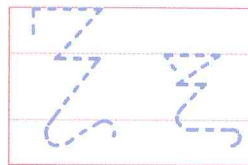
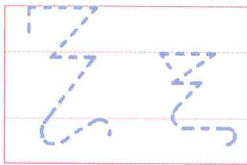
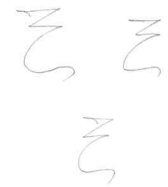
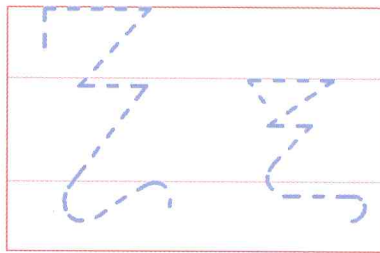
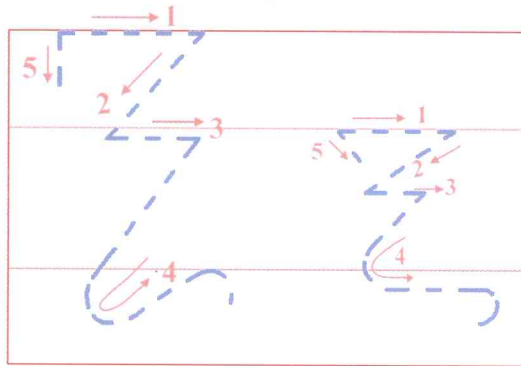

+ كَرَّرَ العَمَل في باقى المَقاسات.

+ وَصَلَ النِّقْط مُتتَبِعاً الأَسْهُم في الشَّكْل الكَبِير.

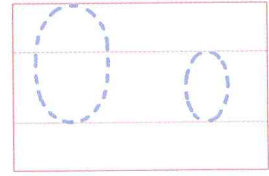
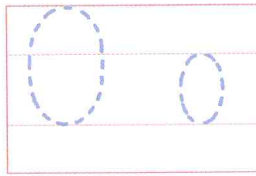
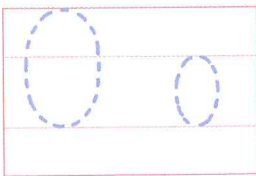
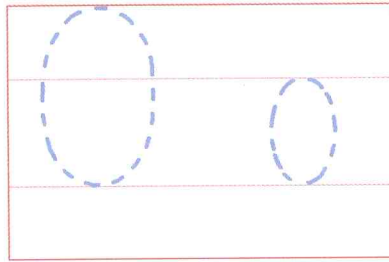
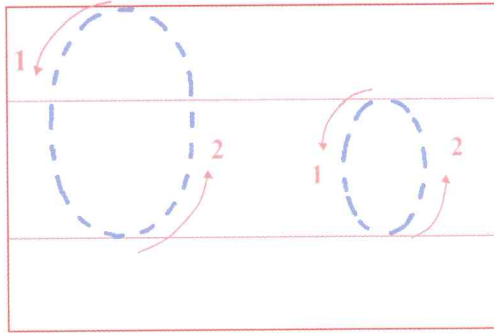

+ كرّر العمل في باقي المقاسات.

+ وصل النقط مُتتبعاً الأسهم في الشكل الكبير.

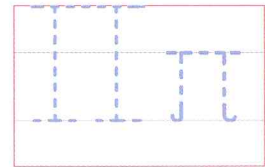
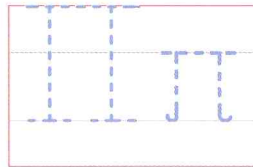
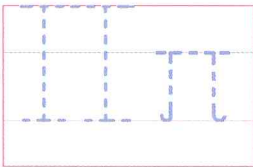
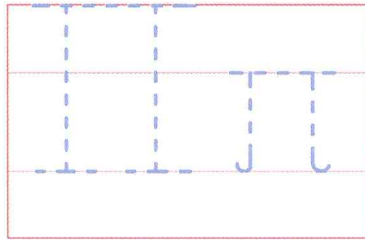
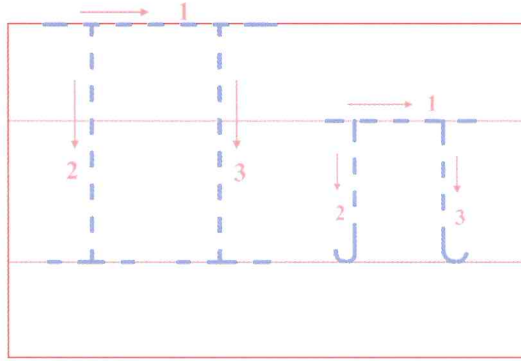
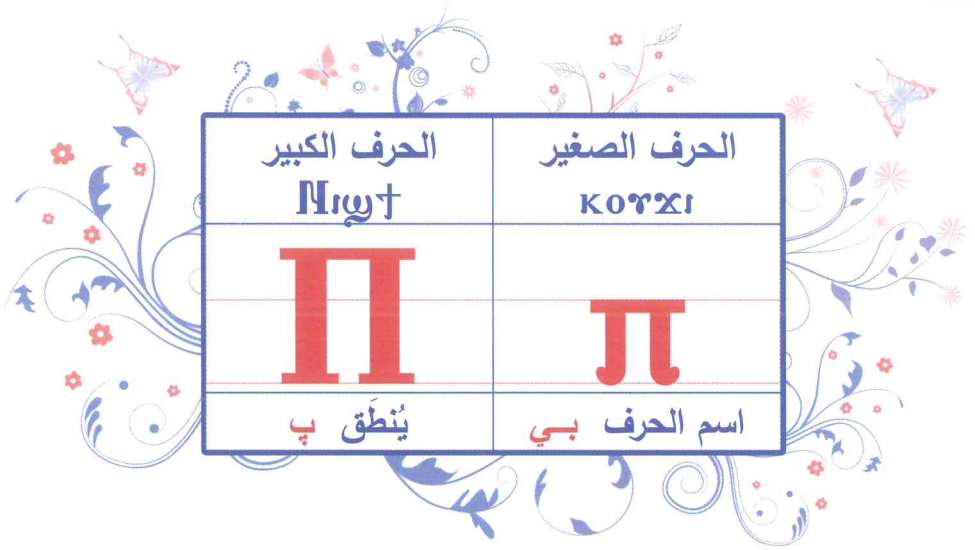

+ كَرَّرَ العمل في باقي المقاسات.

+ وَصَلَ النقط مُتتَبِعاً الأَسْهُمَ في الشكْلِ الكَبِيرِ.

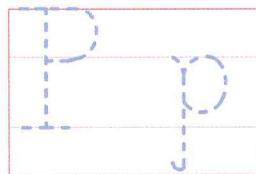
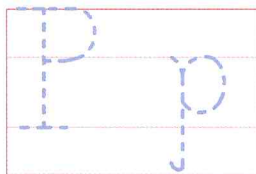
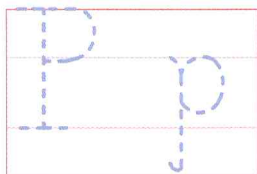
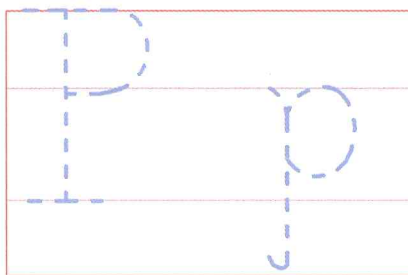
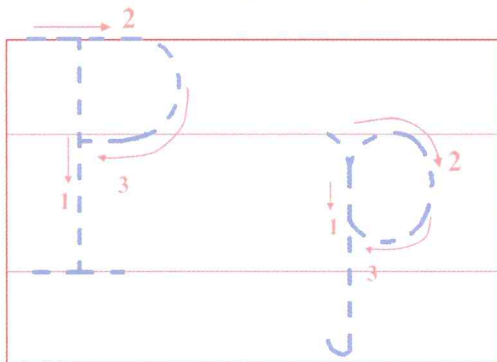
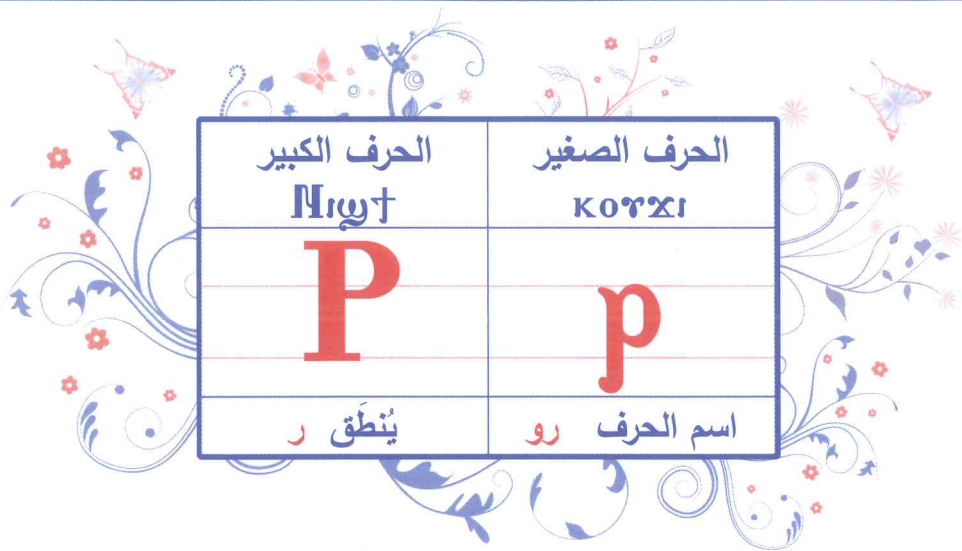

+ كَرِّرِ الْعَمَلِ فِي بَاقِي الْمَقَاسَاتِ.

+ وَصَلِ النُّقْطَ مُتَتَبِعاً الْأَسْهُمَ فِي الشَّكْلِ الْكَبِيرِ.

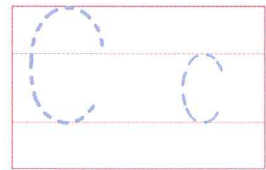
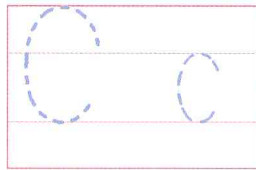
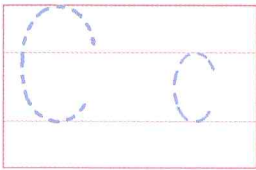
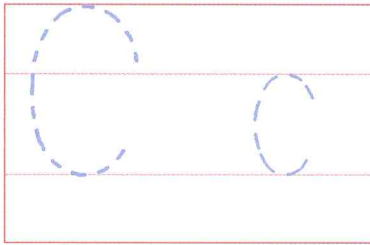
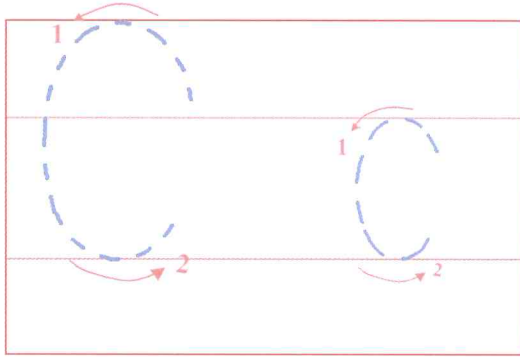
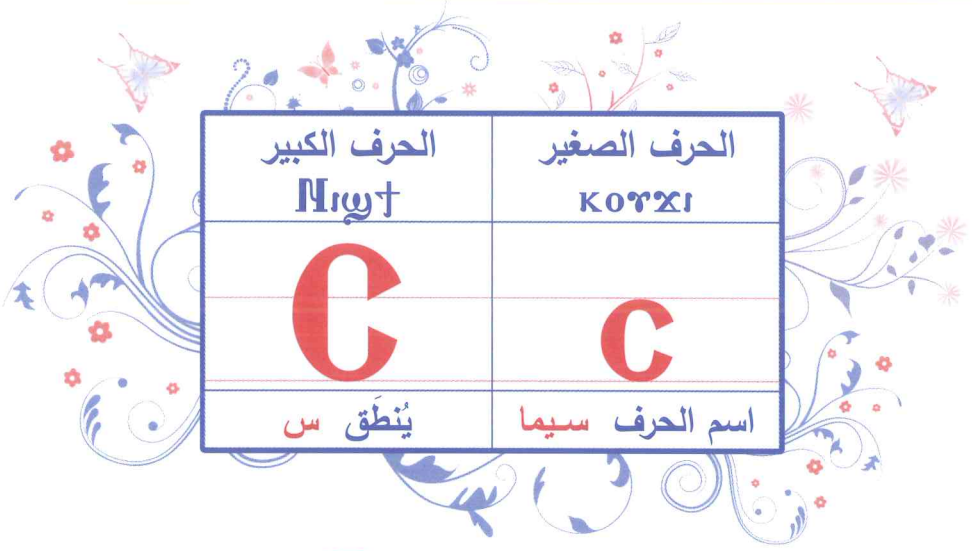

+ كَرِّرِ الْعَمَلِ فِي بَاقِي الْمَقَاسَاتِ .

+ وَصِّلِ النِّقْطَ مُتَّبِعاً الْأَسْهَمَ فِي الشَّكْلِ الْكَبِيرِ .

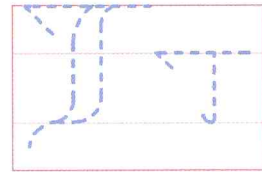
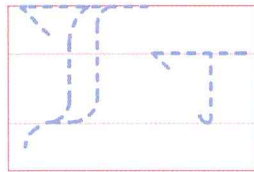
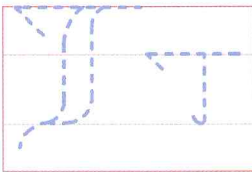
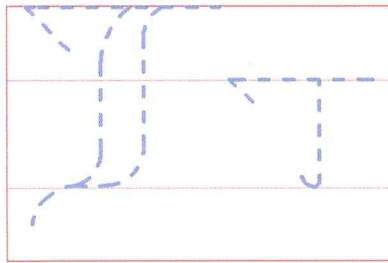
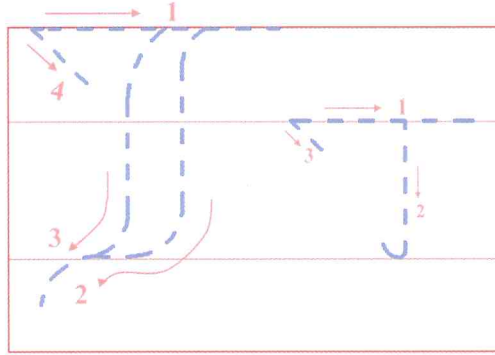
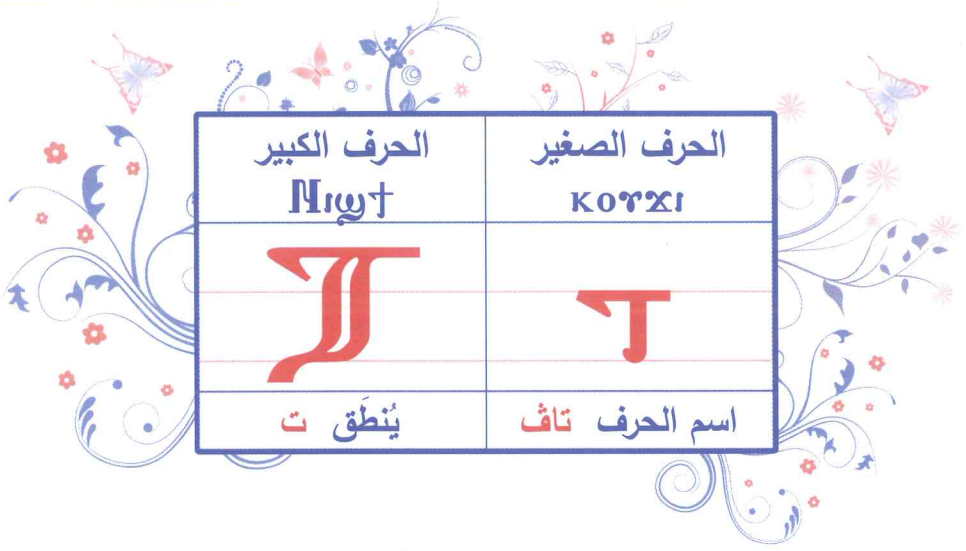

+ كَرَّرَ العمل في باقي المقاسات.

+ وَصَلَ النقط مُتتَبِعاً الأَسْهُمَ في الشكْلِ الكَبِيرِ.

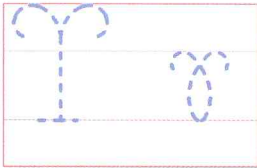
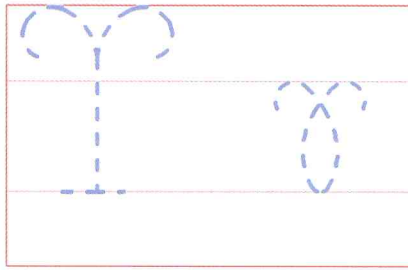
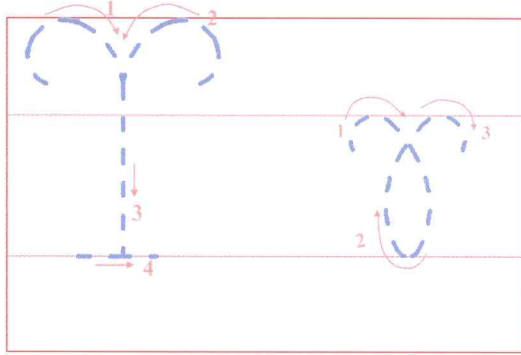
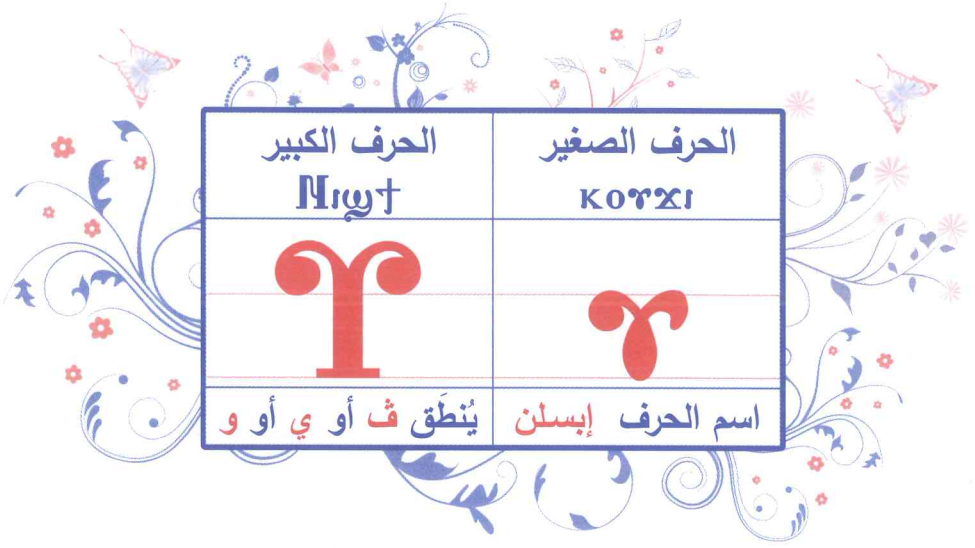

+ كَرِّرِ العَمَلِ فِي بَاقِي المَقَاسَاتِ.

+ وَصِّلِ النِّقْطَ مُتَّبِعاً الأَسْهُمَ فِي الشَّكْلِ الكَبِيرِ.

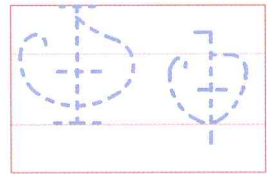
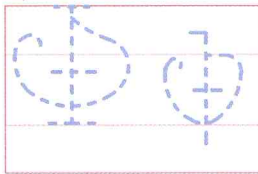
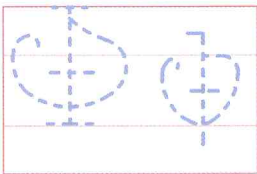
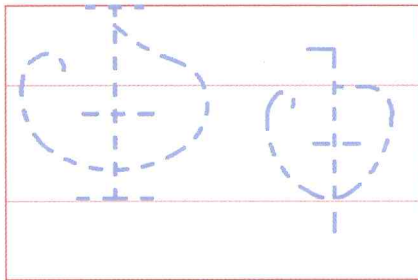
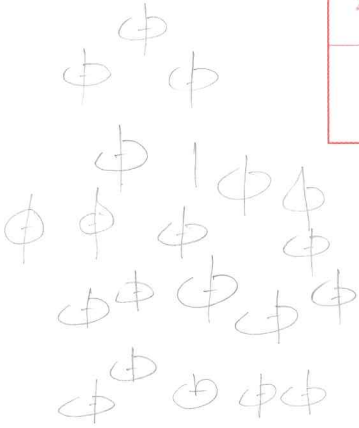
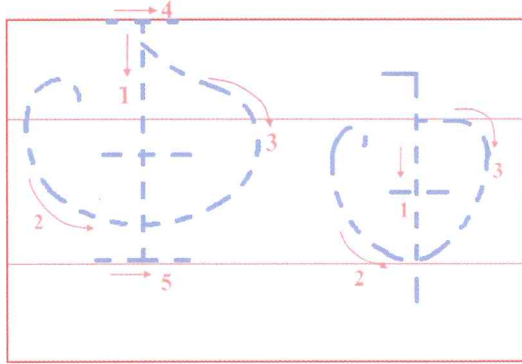
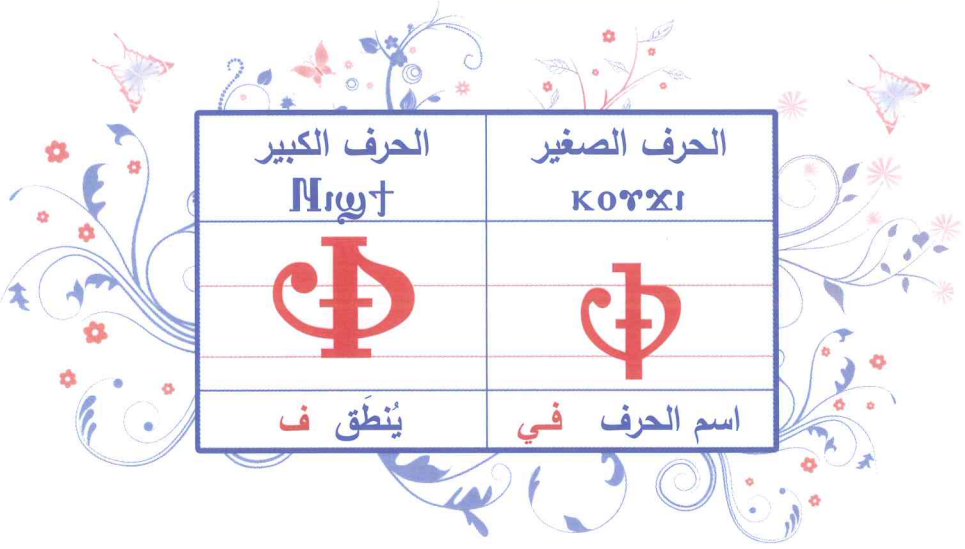

+ كَرِّرِ العَمَلِ فِي بَاقِي المَقَاسَاتِ.

+ وَصَلِ النُقُطَ مُتَتَبِعاً الأَسْهَمَ فِي الشَّكْلِ الكَبِيرِ.

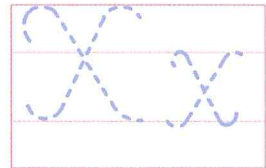
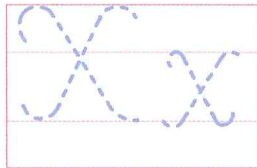
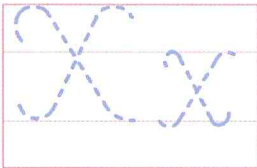
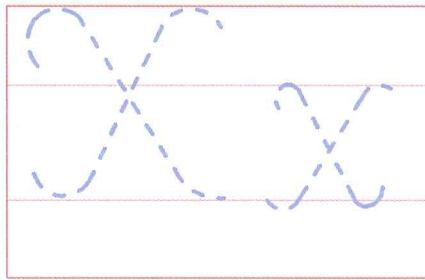
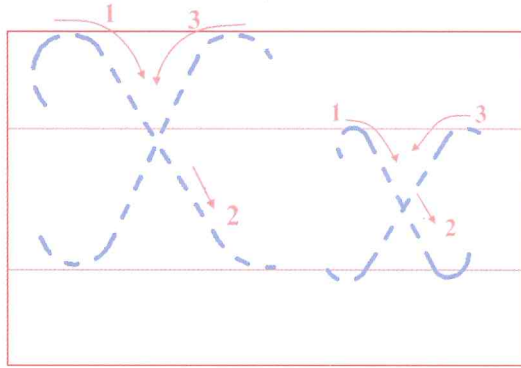

+ كَرّر العمل في باقي المقاسات.

+ وَصَلْ النقط مُتتَبِعاً الأَسْهُم في الشكّل الكَبير.

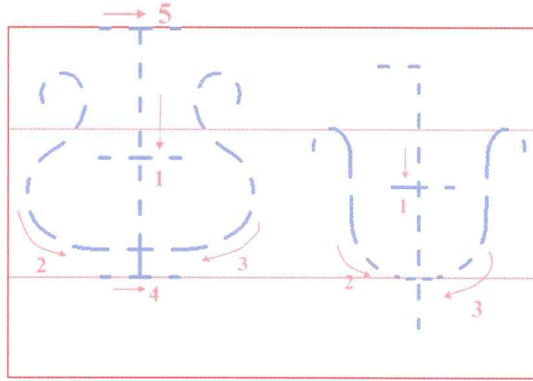

Ψ

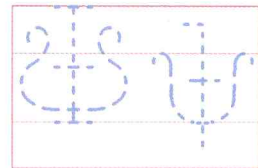
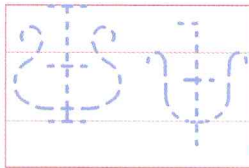
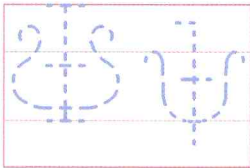
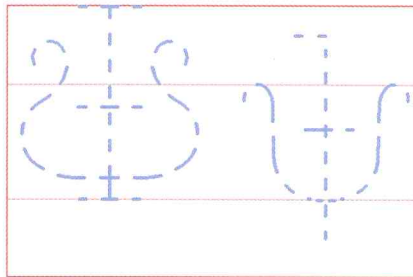

+ كَرِّرِ العَمَلِ فِي بَاقِي المَقَاسَاتِ.

+ وَصِّلِ النِّقْطَ مُتَتَبِعاً الأَسْهَمَ فِي الشَّكْلِ الكَبِيرِ.

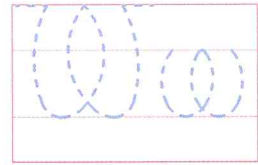
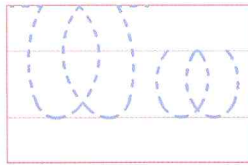
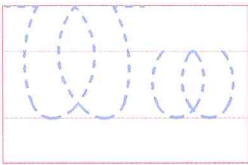
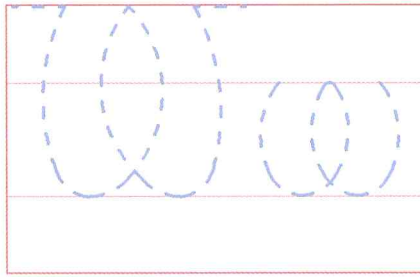
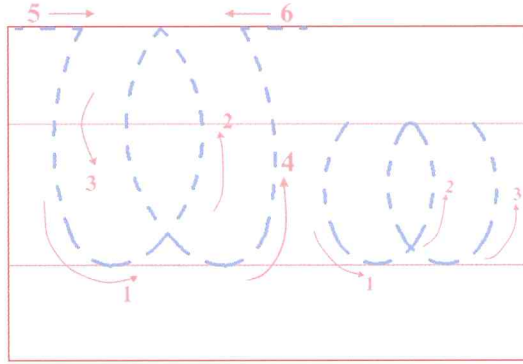

+ كَرَّرَ العمل في باقي المقاسات.

+ وَصَلَ النقط مُتَتَبِعاً الأسم في الشكل الكبير.

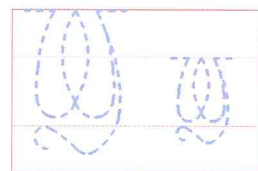
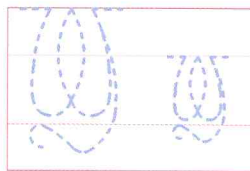
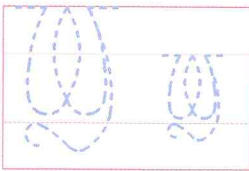
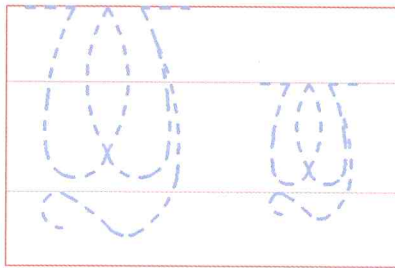
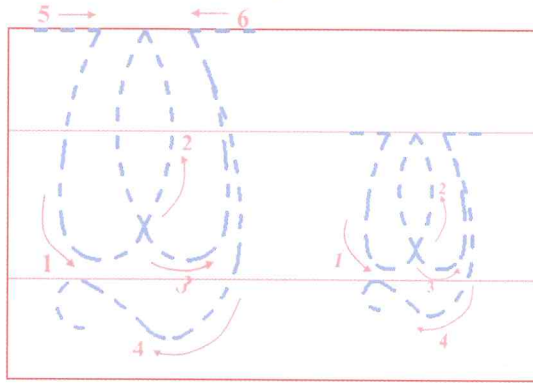

+ كرّر العمل في باقي المقاسات.

+ وصل النقط مُتتبعاً الأسهم في الشكل الكبير.



الحرف الكبير Fay ف	الحرف الصغير Korzi ف
يُنطق ف	اسم الحرف فاي

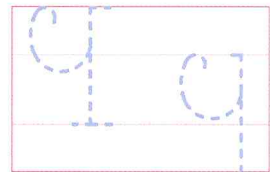
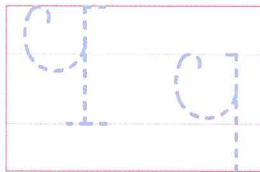
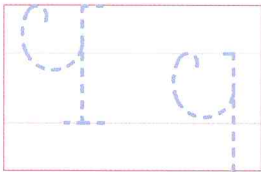
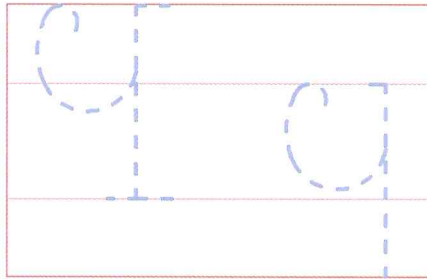
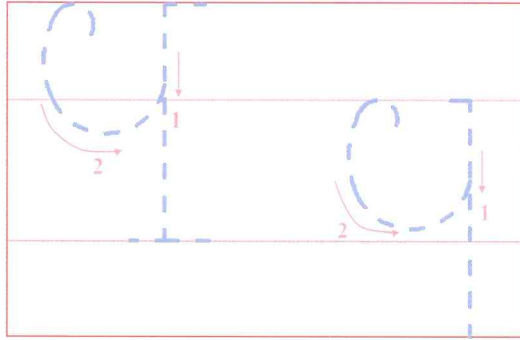

+ كرّر العمل في باقي المقاسات.

+ وصل النقط مُتتبعاً الأسهم في الشكل الكبير.

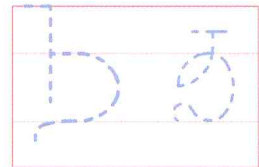
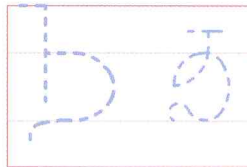
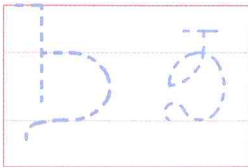
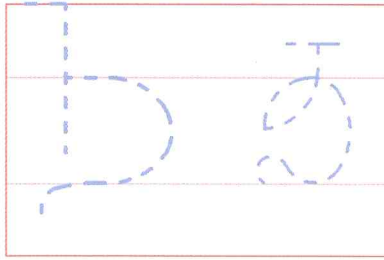
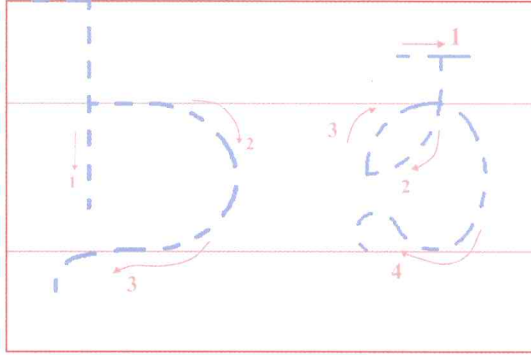

+ كَرِّرِ الْعَمَلِ فِي بَاقِي الْمَقَاسَاتِ.

+ وَصِّلِ النِّقْطَ مُتَّبِعاً الْأَسْهُمَ فِي الشَّكْلِ الْكَبِيرِ.

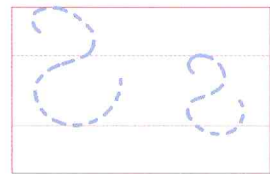
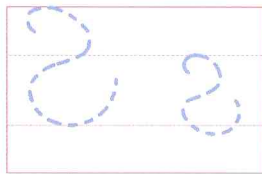
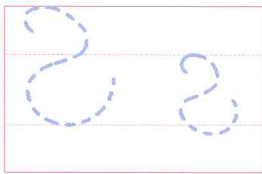
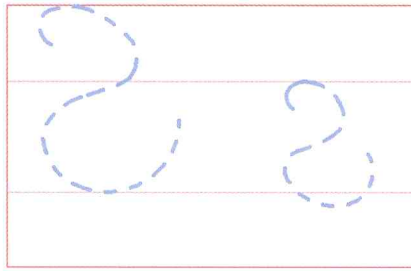
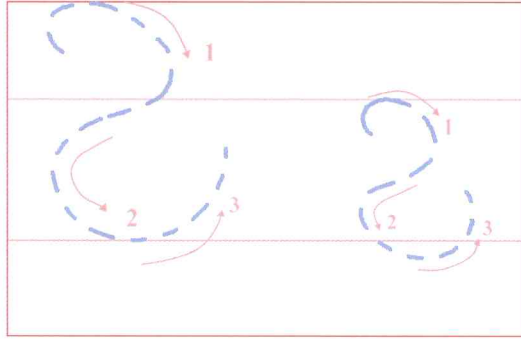

+ كرر العمل في باقي المقاسات.

+ وصل النقط متتبعاً الأسهم في الشكل الكبير.

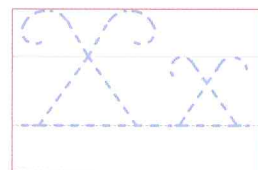
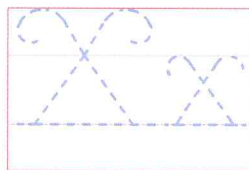
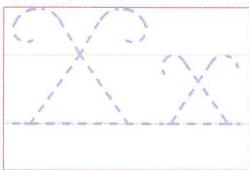
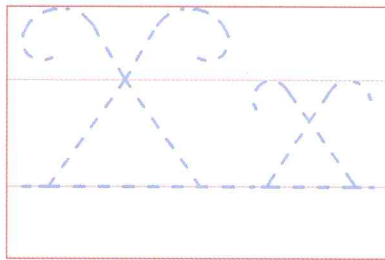
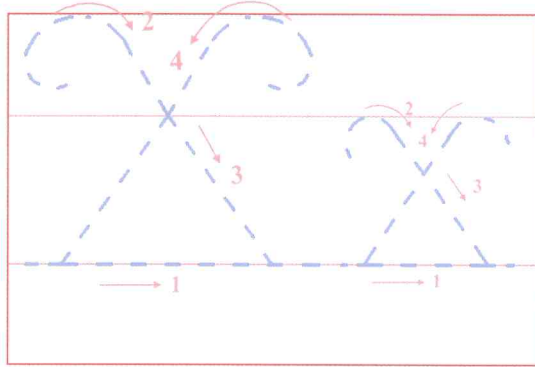

+ كَرِّرِ الْعَمَلِ فِي بَاقِي الْمَقَاسَاتِ.

+ وَصِّلِ النِّقْطَ مُتَّبِعاً الْأَسْهُمَ فِي الشَّكْلِ الْكَبِيرِ.

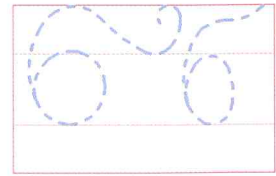
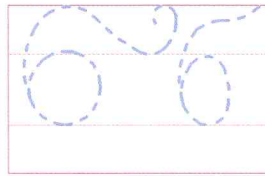
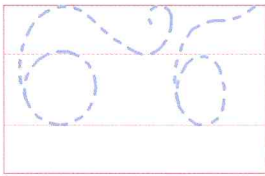
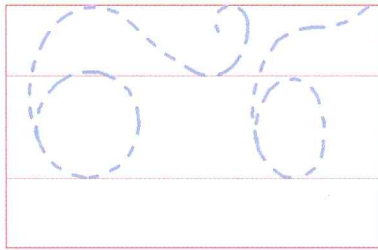
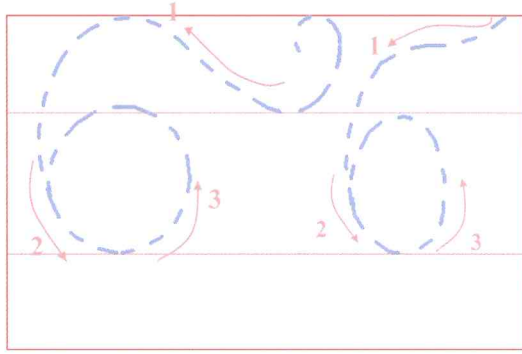

+ كَرِّرِ العَمَلِ فِي بَاقِي المَقَاسَاتِ.

+ وَصِّلِ النِّقْطَ مُتَّبِعاً الأَسْهَمَ فِي الشَّكْلِ الكَبِيرِ.

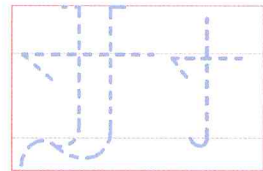
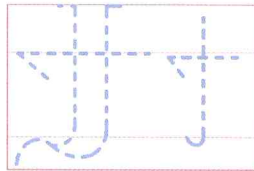
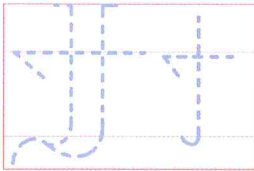
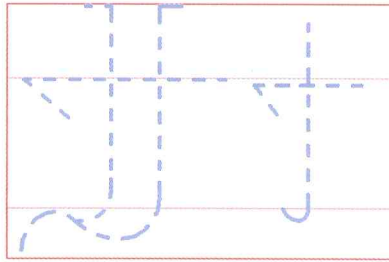
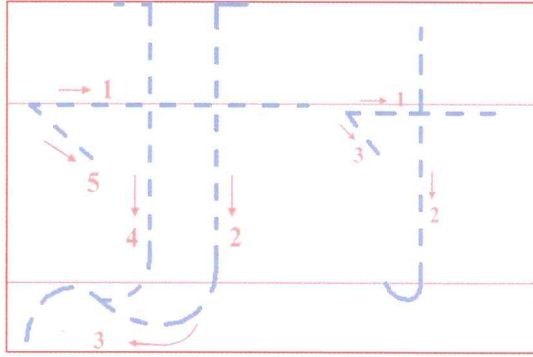
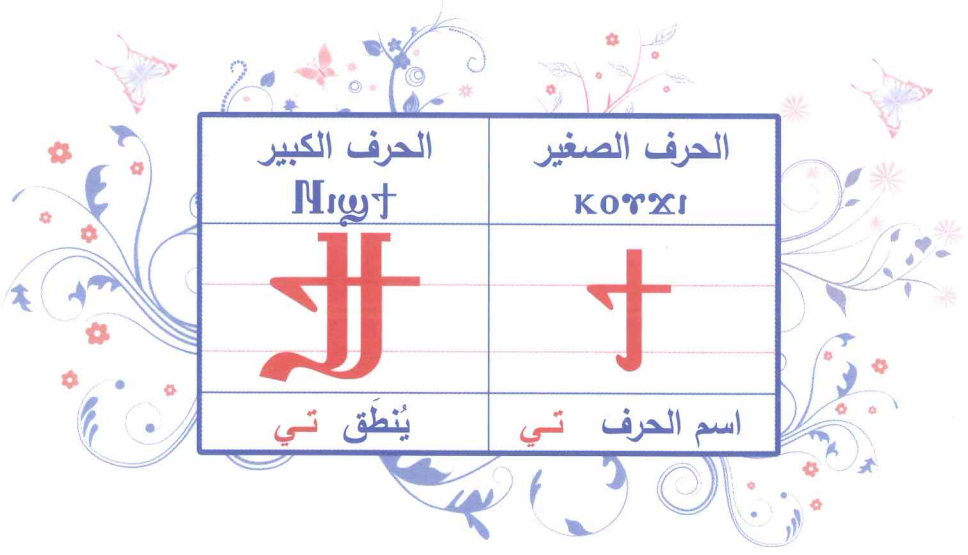

+ كَرَّرَ العمل في باقي المقاسات.

+ وَصَلَ النقط مُتَّبِعاً الأَسْهُمَ فِي الشَّكْلِ الكَبِيرِ.

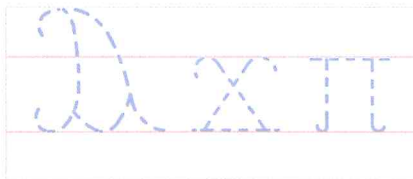
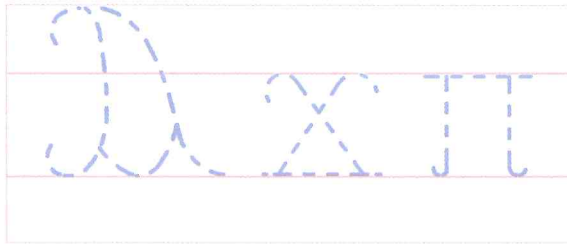
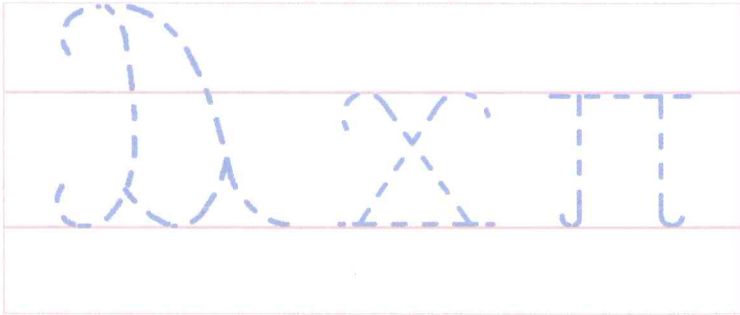

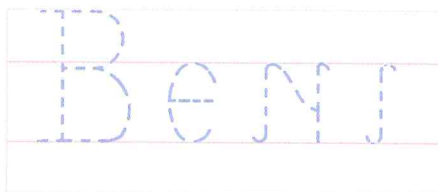
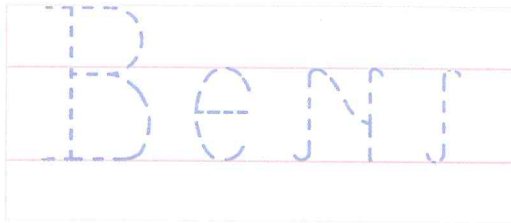
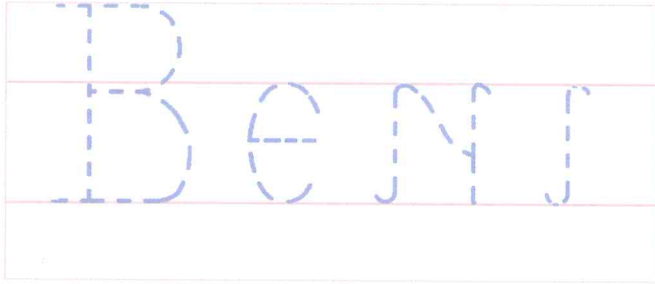

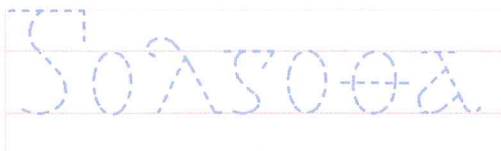
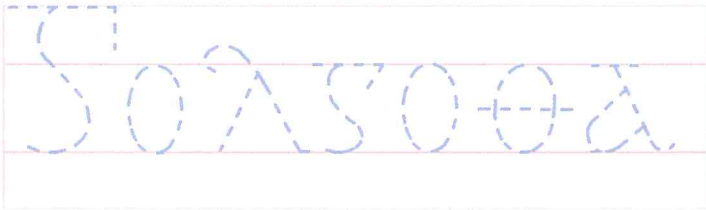

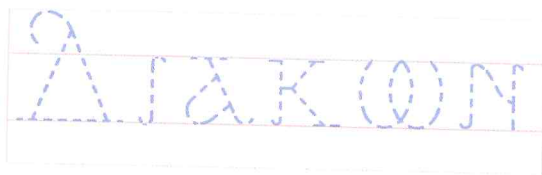
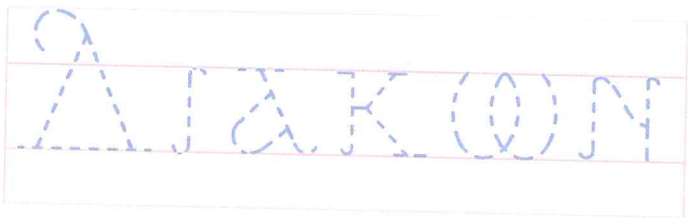
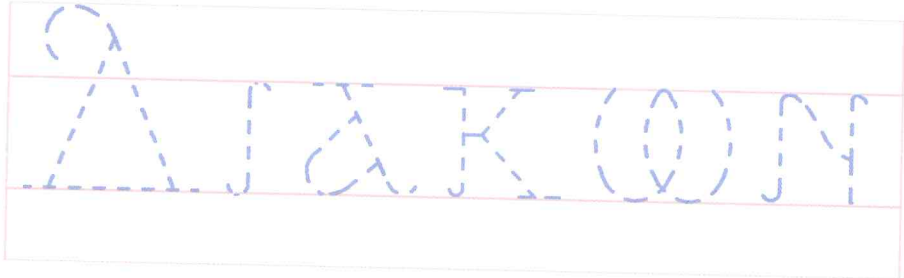
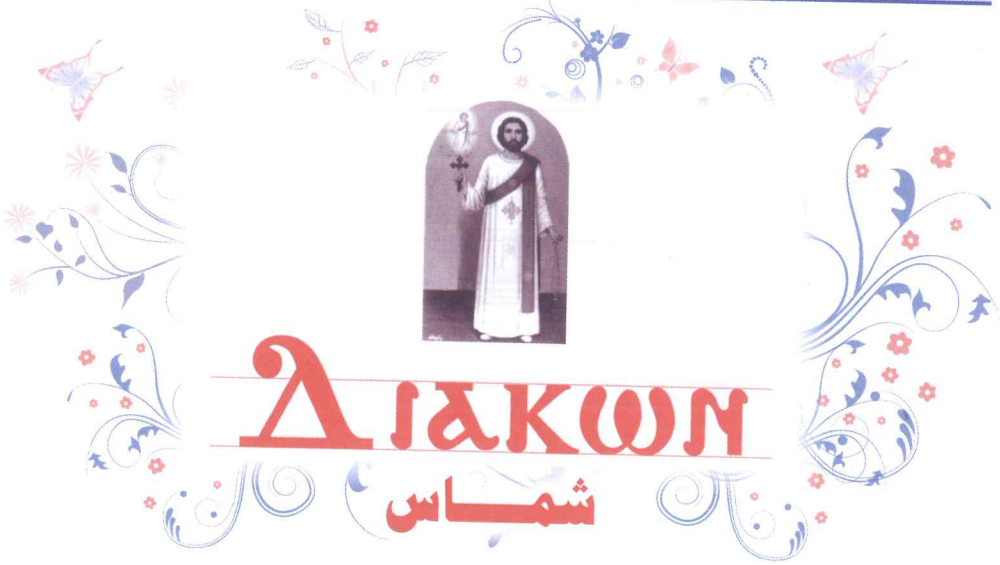

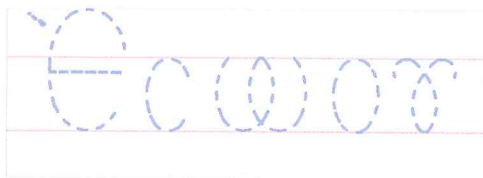
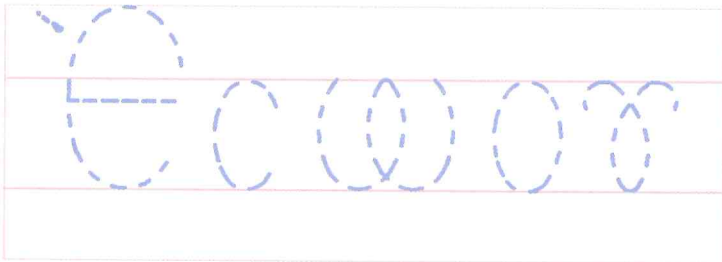
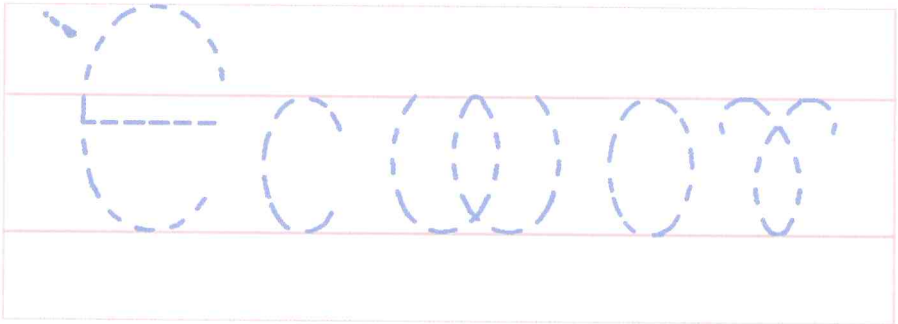

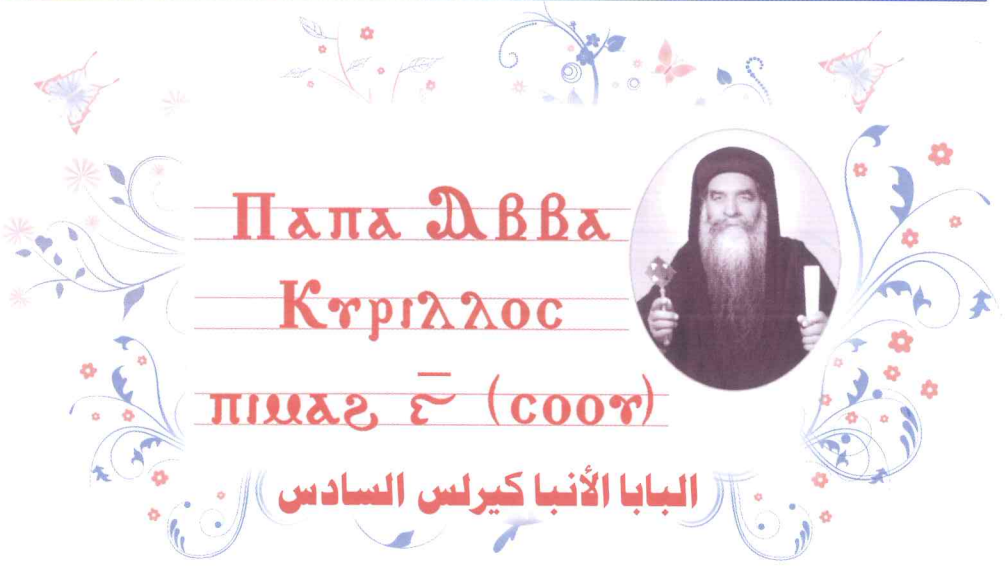

Παπα Ἀββα  
 Κυριλλος  
 πωαζ ε̅ (σοοϥ)

Παπα Ἀββα  
 Κυριλλος  
 πωαζ ε̅ (σοοϥ)

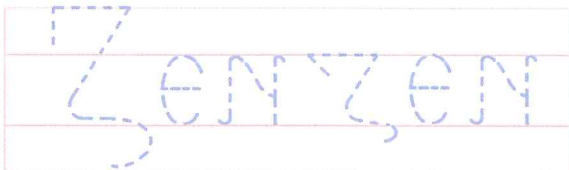
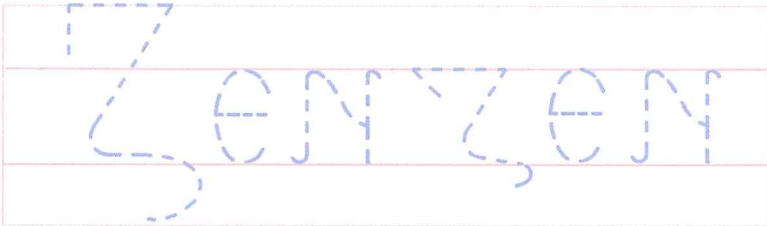
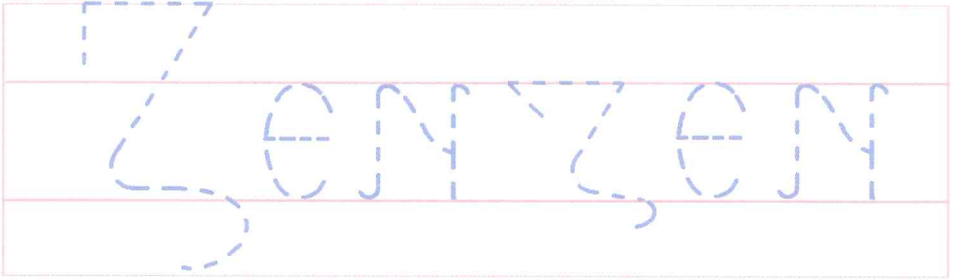

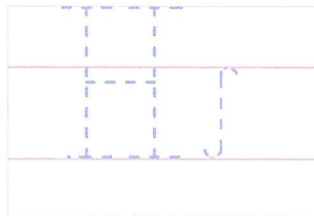
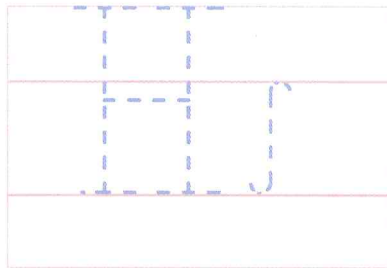
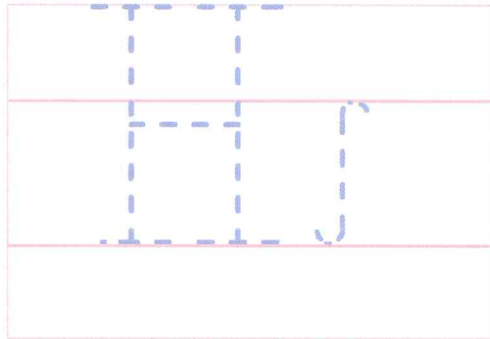

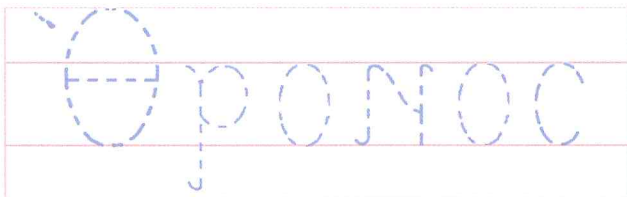
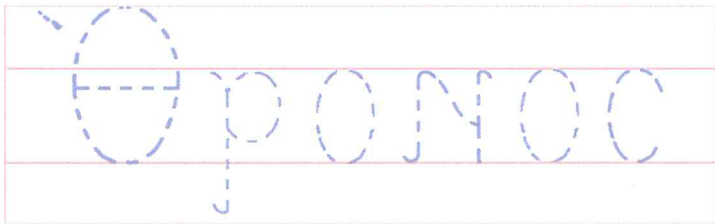
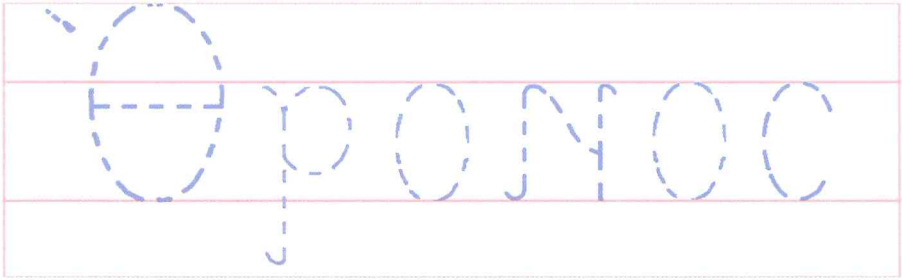

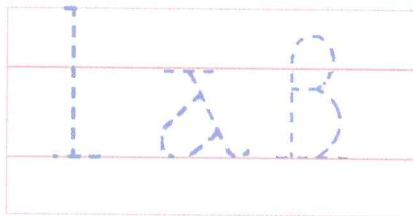
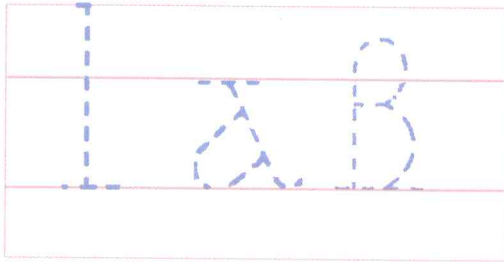
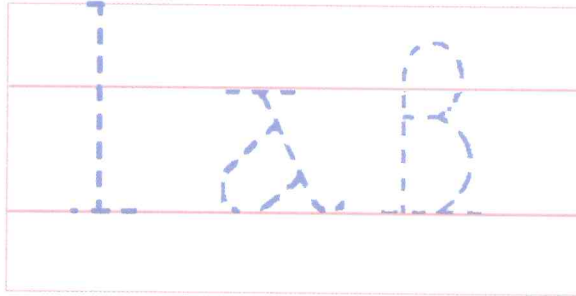
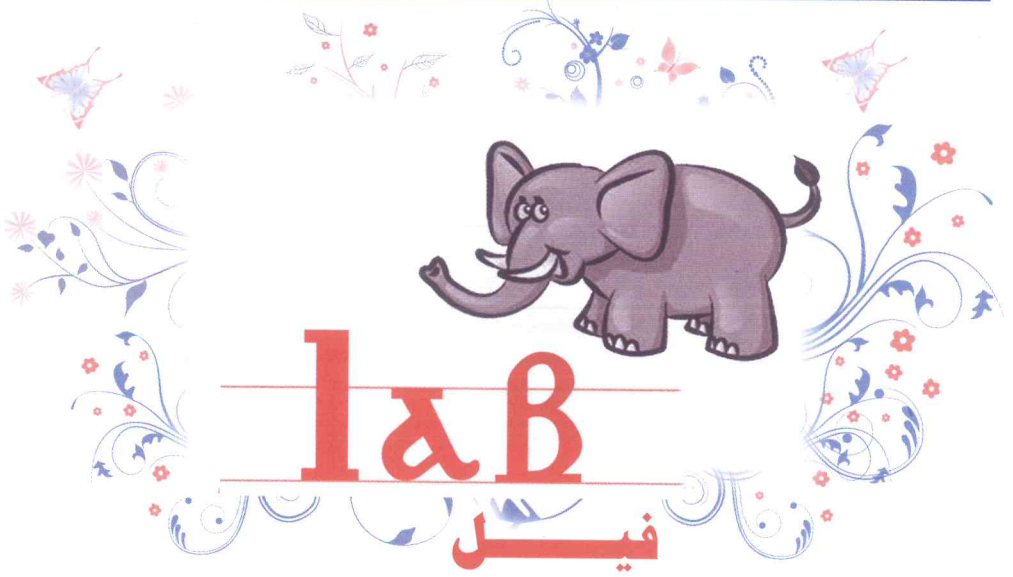

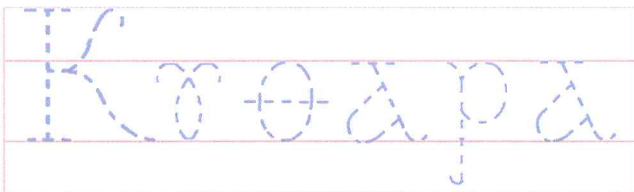
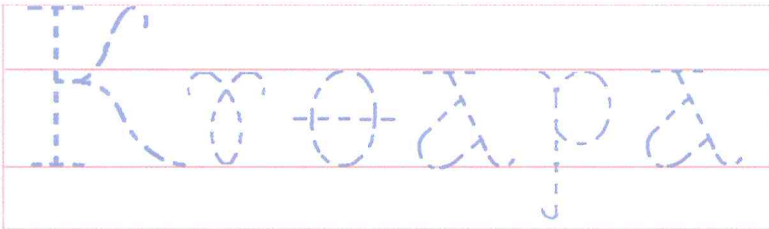
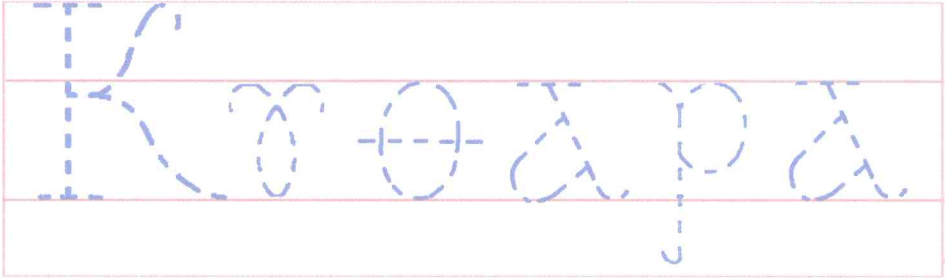

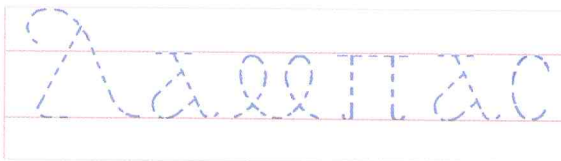
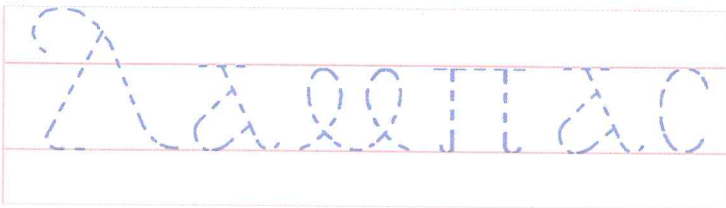
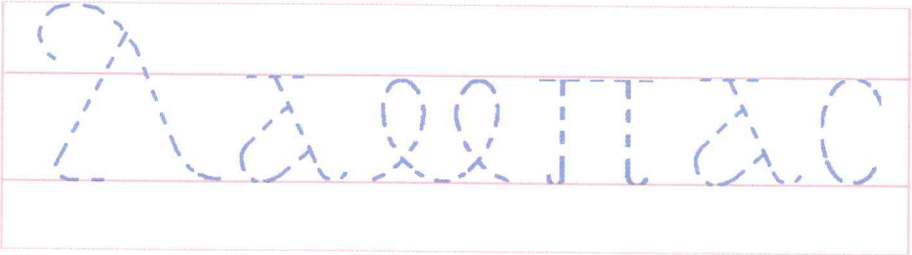

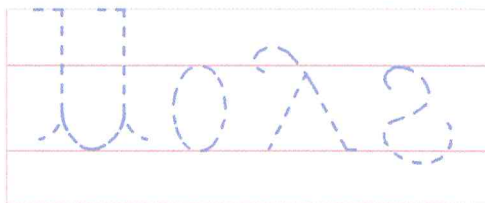
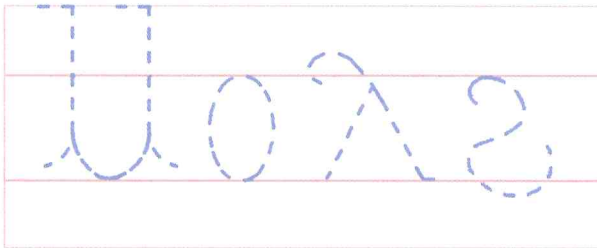
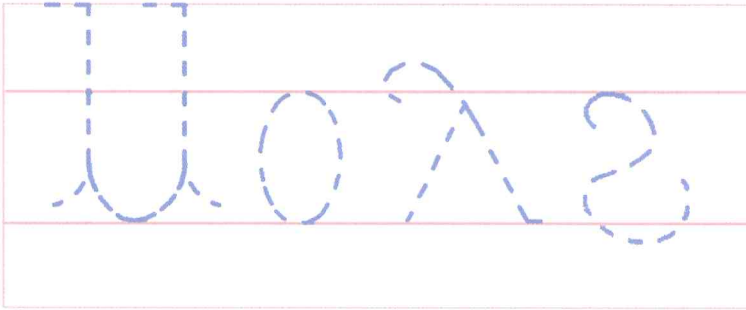

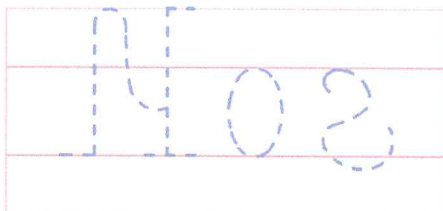
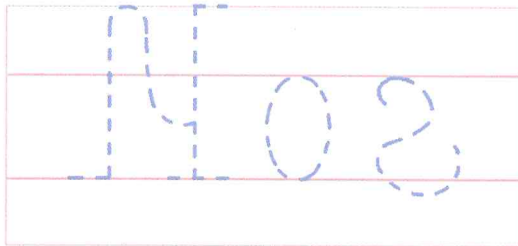
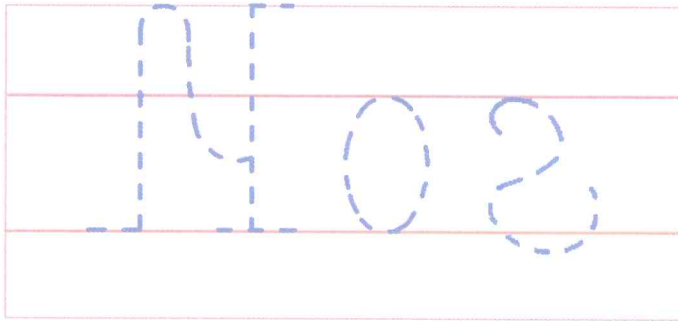

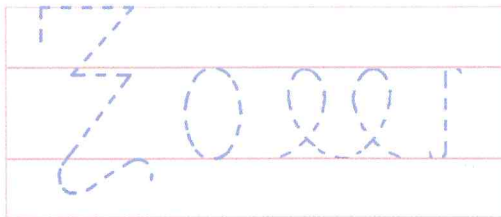
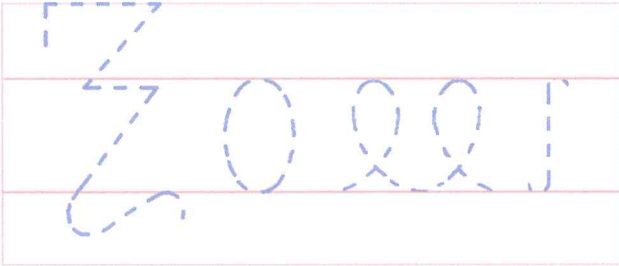
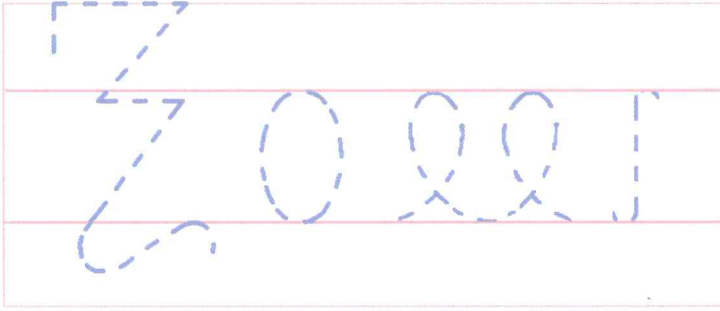



فلاح

فلاح

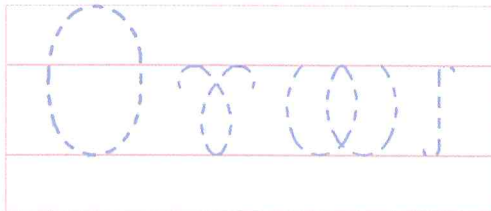
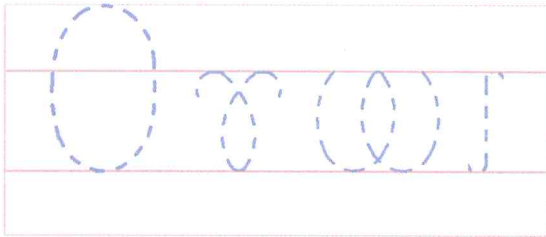
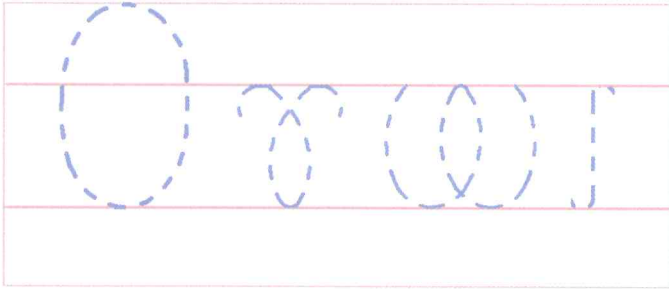



Παπα Αββα

Παωαδροσ

Παπα Αββα

Παωαδροσ

Παπα Αββα

Παωαδροσ

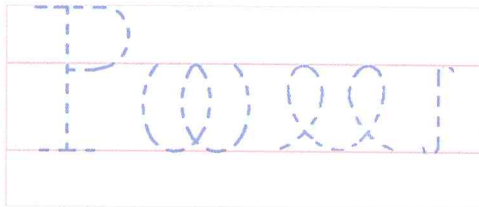
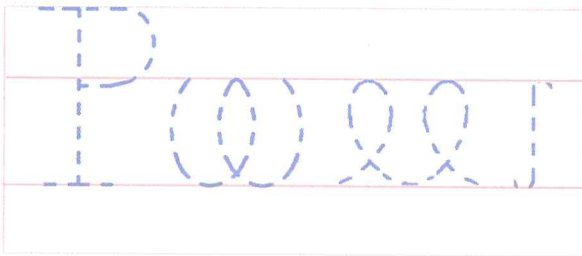
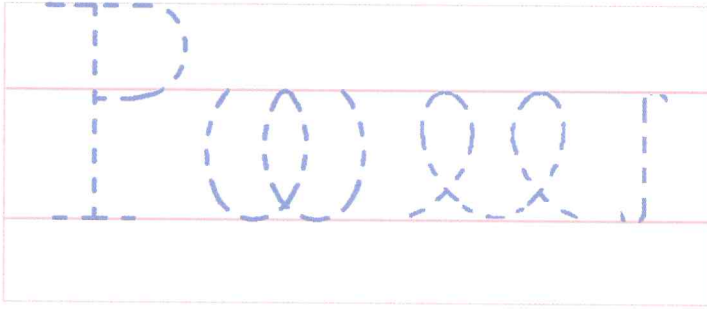

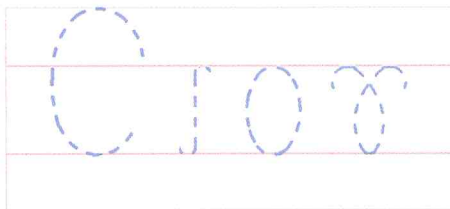
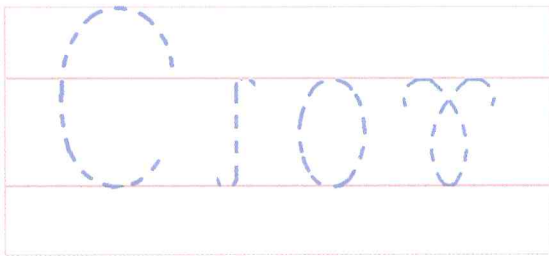
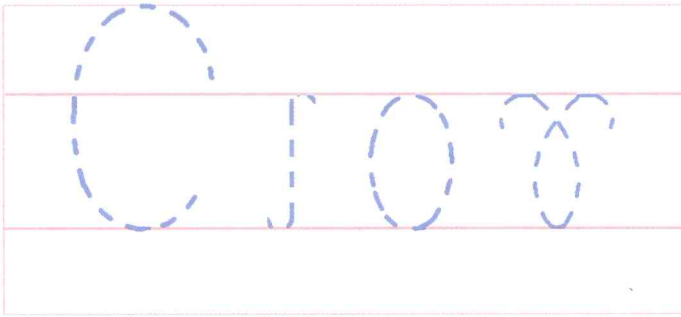

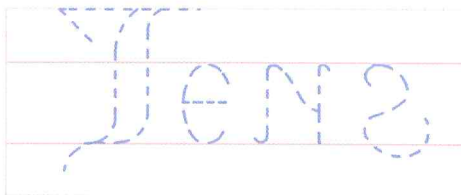
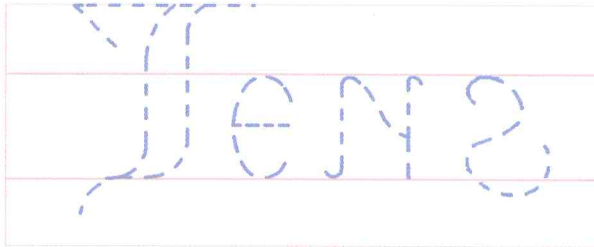
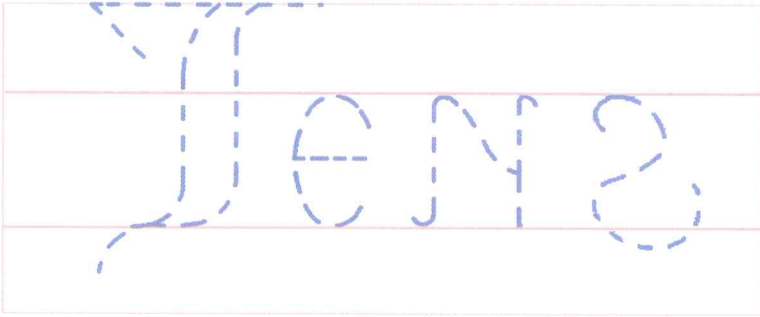



ΓΛΑΥΤΗΡΙΟΝ

ΓΛΑΥΤΗΡΙΟΝ

ΓΛΑΥΤΗΡΙΟΝ

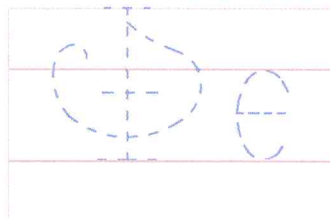
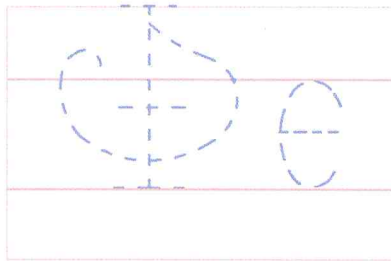
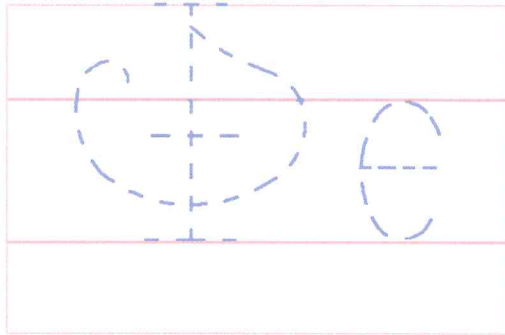

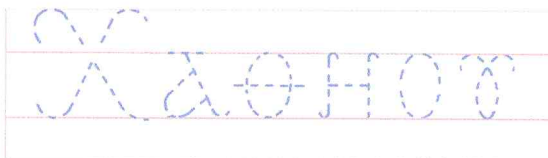
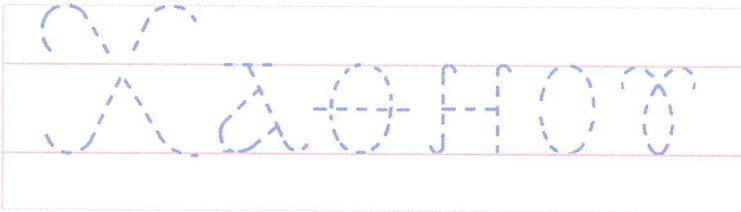
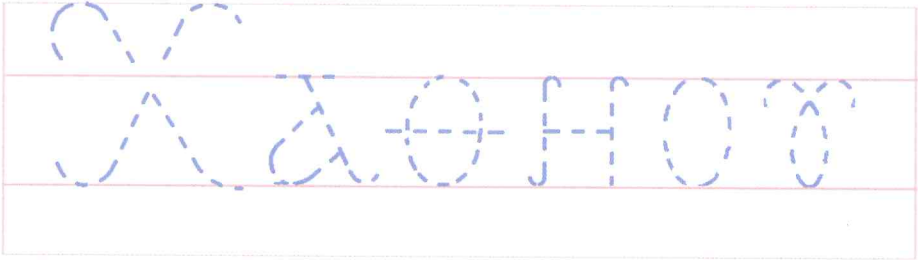

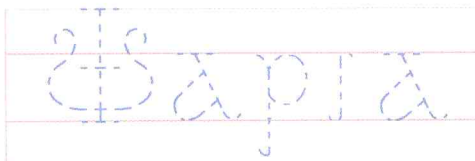
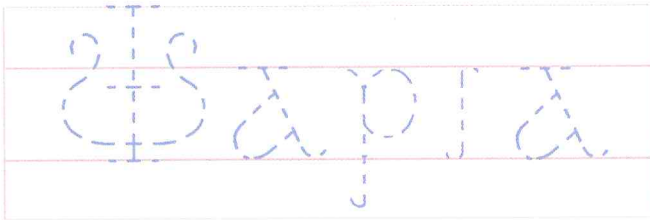
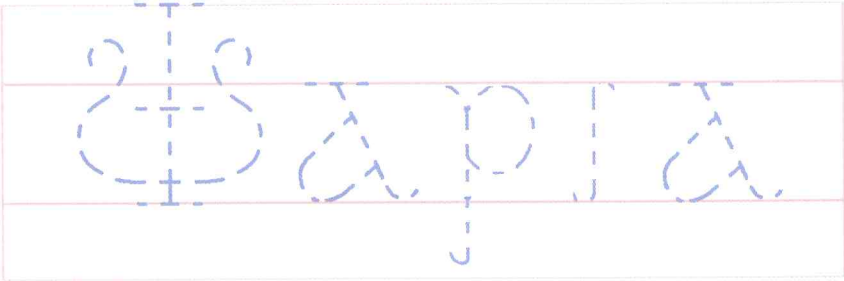

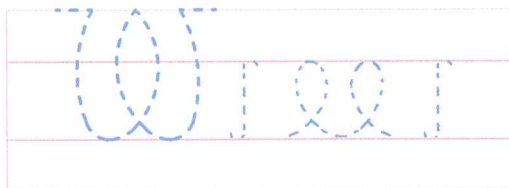
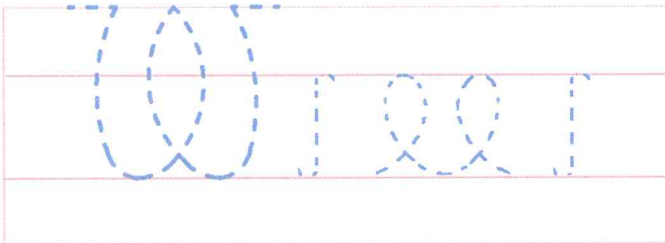
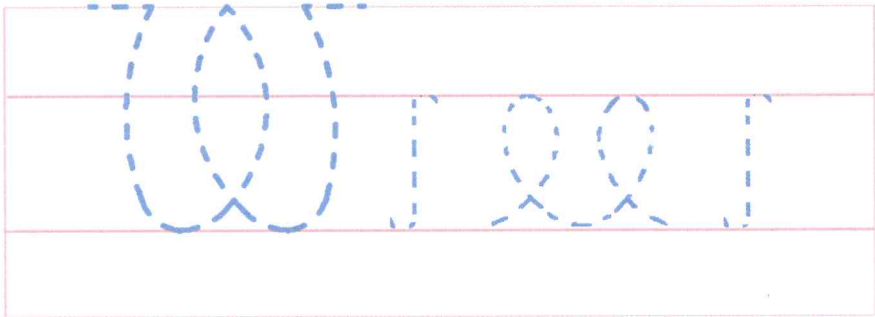

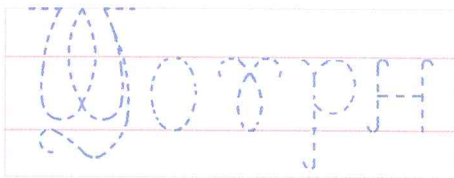
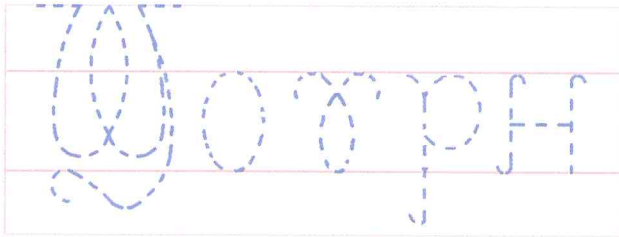
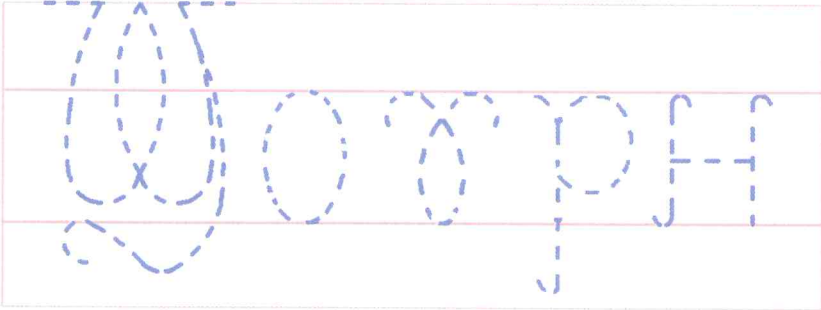

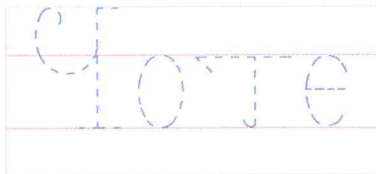
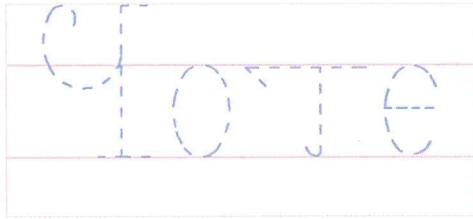
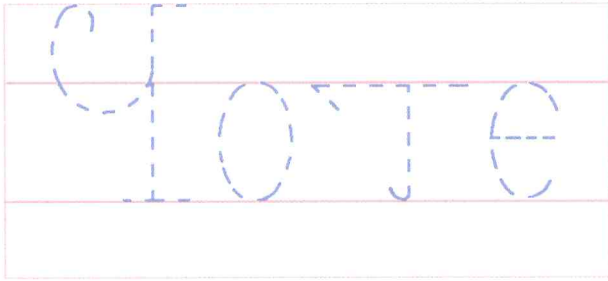

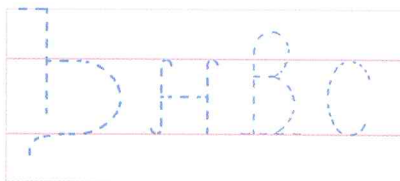
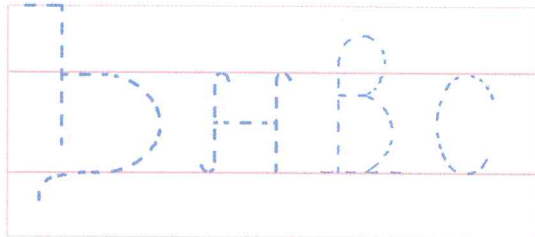
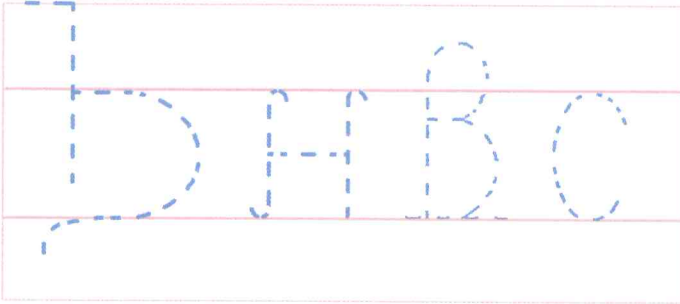

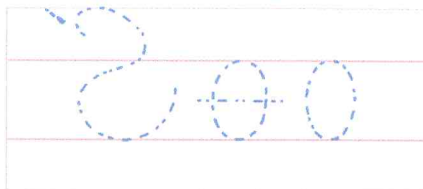
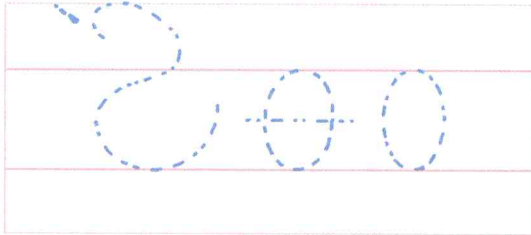
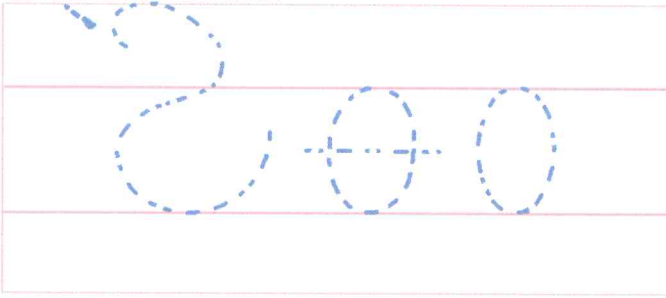

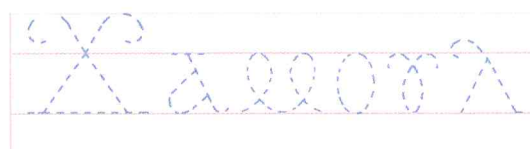
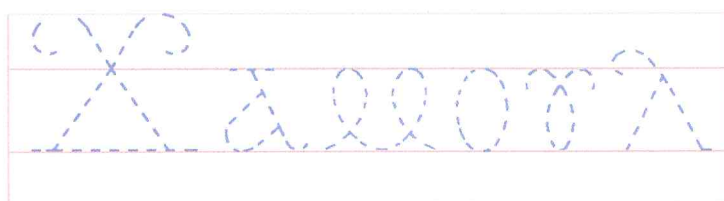
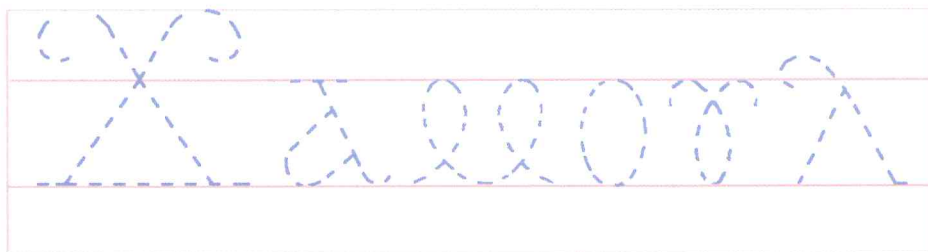
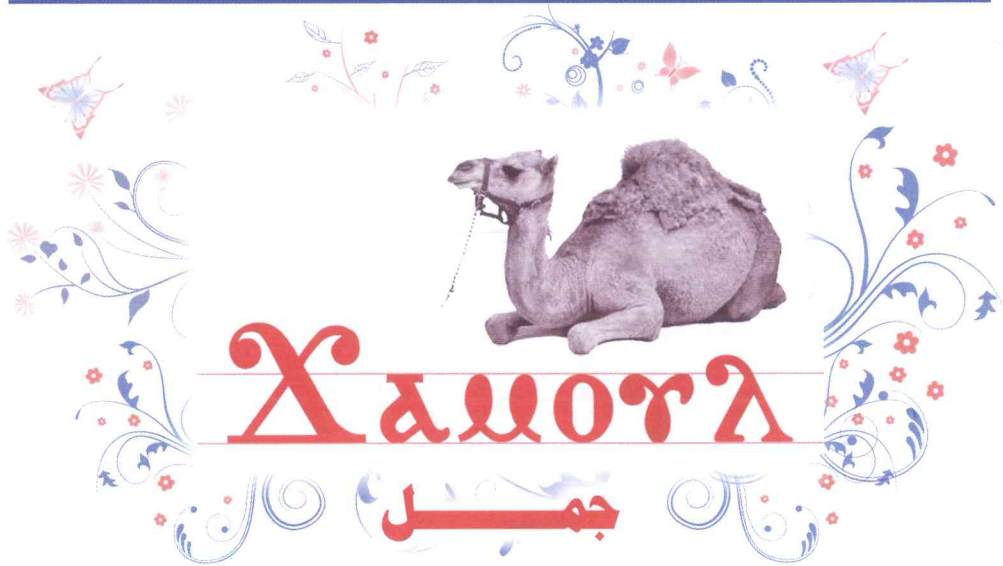

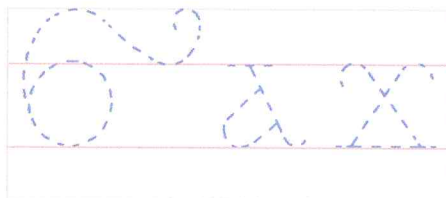
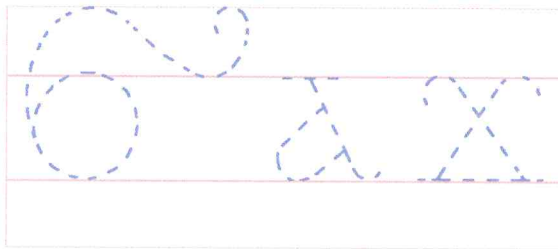
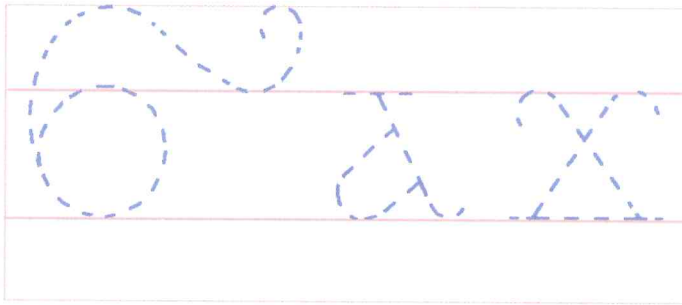

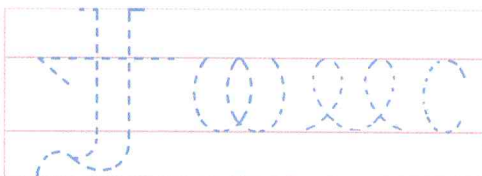
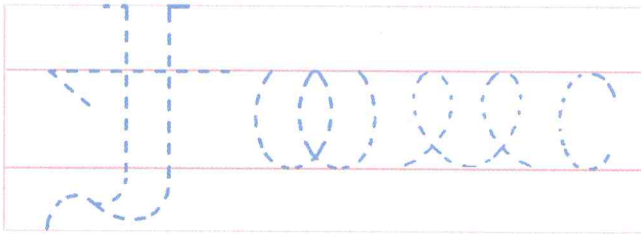
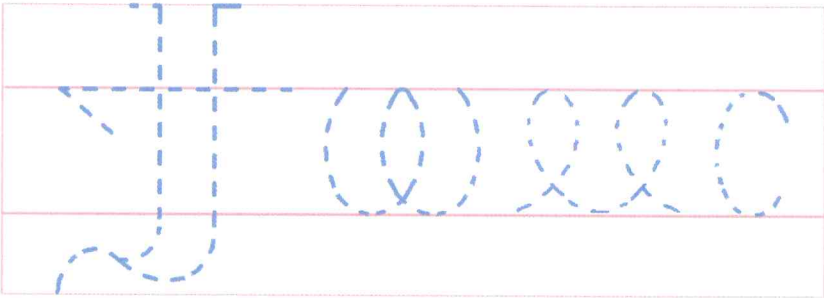



ΖΑΝΝΗΝΙ

ΕΒΟΛΘΕΝ

ΠΙΧΩ ΕΘΟΥΑΒ

بعض

الآيات

من

الكتاب المقدس



# ΦΨ ΟΥΑΣΑΠΗ ΠΕ

الله محبة ( ١ يو ٤ : ١٦ )

ΦΨ ΟΥΑΣΑΠΗ ΠΕ

ΦΨ ΟΥΑΣΑΠΗ ΠΕ

ΦΨ ΟΥΑΣΑΠΗ ΠΕ



# Центре неҗетеләрниоҗ

أحبوا بعضكم بعضاً ( ١ بط ١ : ٢٢ )

Центре неҗетеләрниоҗ

Центре неҗетеләрниоҗ

Центре неҗетеләрниоҗ



# Ποι δεν πιπνευα

اسكوا بالروح (غل ٥ : ١٦)

Ποι δεν πιπνευα

Ποι δεν πιπνευα

Ποι δεν πιπνευα



# Ἡπερρενε πικοςσος

لا تحبوا العالم ( ١ يو ٢ : ١٥ )

Ἡπερρενε πικοςσος

Ἡπερρενε πικοςσος

Ἡπερρενε πικοςσος



ΑΝΟΚ ΠΕ ΠΩΙΚ

ΝΤΕ ΠΩΝΘ

أنا هو خبز الحياة (يو ٦ : ٣٥)

ΑΝΟΚ ΠΕ ΠΩΙΚ

ΝΤΕ ΠΩΝΘ

ΑΝΟΚ ΠΕ ΠΩΙΚ

ΝΤΕ ΠΩΝΘ

ΑΝΟΚ ΠΕ ΠΩΙΚ

ΝΤΕ ΠΩΝΘ



# ΚΗΝ ἔροκ ἐπαγγέλλοτ

تَكْفِيكَ هَذِهِ النِّعْمَةُ ﴿تَكْفِيكَ نِعْمَتِي﴾ (٢ كو ١٢ : ٩)

ΚΗΝ ἔροκ ἐπαγγέλλοτ

ΚΗΝ ἔροκ ἐπαγγέλλοτ

ΚΗΝ ἔροκ ἐπαγγέλλοτ



Ραυι δ̣εν Π̄ο̄ς

Ἰ̄νηοῦ̄ ν̄ιβεν

أفرحوا في الرب كل حين ( في ٤ : ٤ )

Ραυι δ̣εν Π̄ο̄ς

Ἰ̄νηοῦ̄ ν̄ιβεν

Ραυι δ̣εν Π̄ο̄ς

Ἰ̄νηοῦ̄ ν̄ιβεν

Ραυι δ̣εν Π̄ο̄ς

Ἰ̄νηοῦ̄ ν̄ιβεν



Α Β Γ Δ Ε Ζ Η Θ Ι Κ Λ Μ Ν Ξ Ο Π Ρ Σ  
Τ Υ Φ Χ Ψ Ω Ϙ ϙ Ϛ ϛ Ϝ ϝ Ϟ ϟ

Πρωτα ἱερωσύνη ὑπαρχοῦσά  
ὑπερρεμῆσθαι

كراسته الخط القبطي

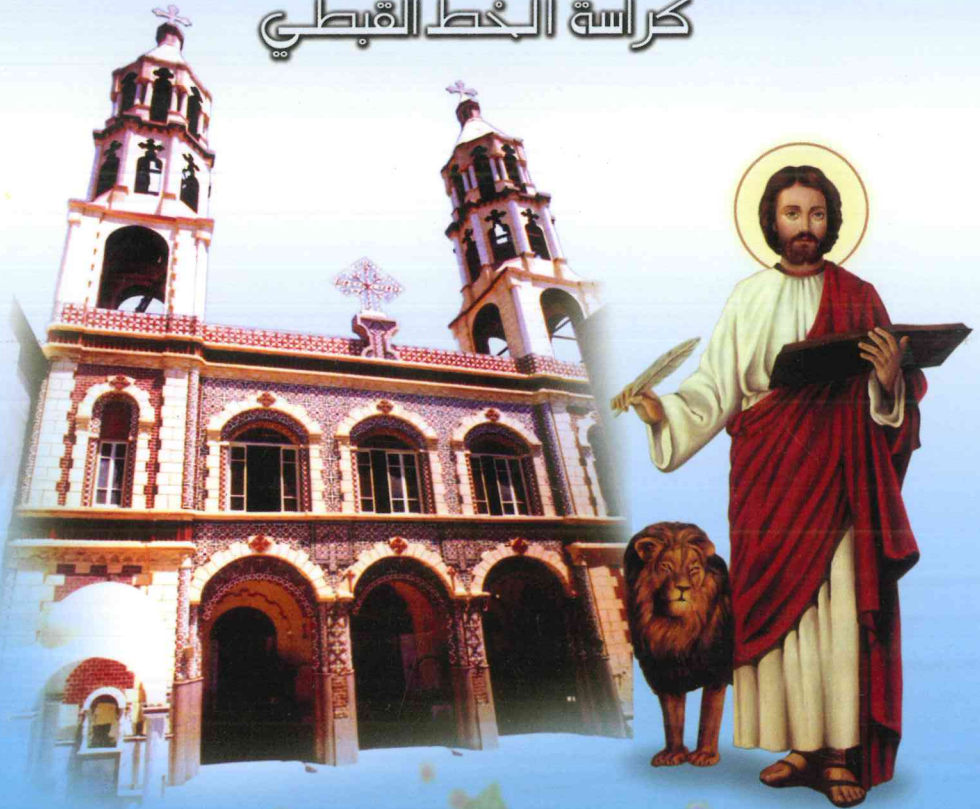

يُطلب من: مطرانية ملوي وأنصنا والأشمونين ص . ب ١٣

web site : [www.mallawi-demet.org](http://www.mallawi-demet.org)